



Health&Safety

HEALTH CARE



HEALTH CARE



RAY S.p.A. **PARTNER SEMPRE AFFIDABILE**

Rays S.p.A., dal 1993, è azienda leader nel settore della salute, protezione e cura della persona.

Una realtà marchigiana che si contraddistingue sul mercato italiano e internazionale per responsabilità, innovazione ed affidabilità.

I dispositivi medici **Rays®** sono presenti in oltre 5.000 Ospedali, RSA e Cliniche, esportati in più di 40 paesi del mondo, una dimostrazione tangibile dell'elevato standard qualitativo riconosciuto.

Rays S.p.A. ha investito in ricerca e sviluppo per offrire dispositivi medici e dispositivi di Protezione individuale di alta qualità, tra gli altri, le siringhe ipodermiche **INJ/LIGHT®**, i guanti da esame **Glovely®**, indispensabili in tutte le attività del settore clinico, i prodotti **LIFEGUARD** per la protezione del corpo in tutte le condizioni di utilizzo in piena sicurezza e comfort, l'abbigliamento da lavoro e le calzature di sicurezza a marchio **Technosafe®**.

Un'attenzione costante per la cura ed il benessere della persona che evolve con l'apertura, nel 2015, della nostra sede produttiva dedicata alla cosmesi, dove,

oltre a numerosi progetti di **Private Label**, vengono realizzate le linee **Iodase®**, marchio leader nella cosmetica funzionale, **Lipobreak®**, trattamenti per lo sport, **Àcantha®**, linea viso fitoceutica e **Dermarays®**. Inserita da **Centro Studi Italy Post** nella lista delle 500 aziende più performanti d'Italia del 2019, **Rays S.p.A.** è una realtà internazionale che aspira all'eccellenza, costruendo con passione e determinazione la strada verso il raggiungimento degli obiettivi ed impegnandosi, giorno dopo giorno, per la soddisfazione dei propri clienti, fornitori e collaboratori nei settori: Medica, Farmacia, Antinfortunistica, Retail, GDO, DIY e Cleaning.

Nel 2021 **Rays S.p.A.** riceve il prestigioso premio Best Value Award posizionandosi al primo posto nella categoria **LEONE** (valore > 100mln) tra le aziende che crescono maggiormente in termini di valore.

Nel 2022 **Rays S.p.A.** viene premiata come "**Impresa Champion**" da **Corriere della Sera Economia e Centro Studi ItalyPost**: inserendola tra le 1000 aziende che tra gli anni 2014 e 2020 hanno performato sopra la media.



Sede / Headquarter

DERMARAYS®
DERMOCOSMETICA PER PELLI SENSIBILI

IODASE®

**SPORT
LIPOBREAK®**

IODEX®

GLOVELY®

ÀCANTHA®
Italian

LIFEGUARD

InJ/Light®

TECHNOSAFE®
protection & safety

RELIABLE PARTNER ALWAYS

Rays S.p.A., since 1993, has been a leading company in the sector of health, protection and personal care. A reality from the Marche that stands out on the Italian and international market for responsibility, innovation and reliability.

Rays® medical devices are present in over 5,000 hospitals, nursing homes and clinics, exported to more than 40 countries around the world, a tangible demonstration of the recognized high quality standard.

Rays S.p.A. has invested in research and development to offer high quality medical devices and PPE, among others, **INJ/LIGHT®** hypodermic syringes, **Glovely®** examination gloves, indispensable in all activities in the clinical sector, **LIFEGUARD** products for protection of the body in all conditions of use in complete safety and comfort, **Technosafe®** brand workwear and safety footwear.

A constant attention to the care and well-being of the person that evolves with the opening, in 2015, of our production site dedicated to cosmetics, where, in addition to numerous **Private Label** projects, the

Iodase® lines are created, a leading brand in cosmetics functional, **Lipobreak®**, sports treatments, **Àcantha®**, phytoceutical face line and **Derमारays®**.

Inserted by **Centro Studi Italy Post** in the list of the 500 best performing companies in Italy in 2019, **Rays S.p.A.** is an international reality that aspires to excellence, building the path towards achieving its objectives with passion and determination and committing itself, day after day, to the satisfaction of its customers, suppliers and collaborators in the sectors: Medical, Pharmacy, Accident Prevention, Retail, GDO, DIY and Cleaning.

In 2021 **Rays S.p.A.** receives the prestigious Best Value Award, ranking first in the **LEONE** category (value > 100 million) among the companies that grow the most in terms of value.

In 2022 **Rays S.p.A.** is awarded as **"Enterprise Champion"** by **Corriere della Sera Economia and Centro Studi ItalyPost**: placing it among the 1000 companies that between the years 2014 and 2020 performed above average.



Sala riunioni / Conference room



Magazzino / Warehouse

L'azienda ha la propria sede in una moderna struttura, composta da 8000 m² di magazzini per la logistica, con 1500 m² di uffici e sale multimediali per la formazione tecnica del proprio personale. Rays S.p.A. ha ottenuto la certificazione in conformità alle norme ISO 9001:2015 - ISO 13485:2016 - ISO 14001:2015.

The company has its own modern structured premise with the warehouse of 8000 m² for logistic services and with an office area of 1500m² with multimedia meeting rooms for the technical training of its staff.

Rays S.p.A. has the certification in compliance with the standard ISO 9001:2015 - ISO 13485:2016 - ISO 14001:2015.



Qualità certificata e cosmetica made in Italy

Certified quality and cosmetic made in Italy

Dopo aver affermato la propria leadership all'interno del settore medicale, considerato tra i mercati più esigenti e competitivi, Rays S.p.A. è entrata con successo nel settore dell'igiene quotidiana della persona, con prodotti altamente specializzati per la detersione, l'idratazione e la protezione della pelle. Rays S.p.A. è in grado di garantire i più alti standard qualitativi grazie alla presenza di personale altamente qualificato. L'intero ciclo progettuale e produttivo, dalla fase di Ricerca & Sviluppo alla fase di lavorazione e confezionamento dei prodotti, avviene in Italia, all'interno dello stabilimento produttivo di Osimo conforme alle normative internazionali più restrittive in ogni fase del processo, dalla produzione alla commercializzazione, perseguendo l'obiettivo del miglioramento continuo.

*After affirming its leadership within the medical sector, considered one of the most demanding and competitive markets, **Rays S.p.A.** has successfully entered the daily personal hygiene sector, with highly specialized products for cleansing, moisturizing and protecting the skin. **Rays S.p.A.** is able to guarantee the highest quality standards thanks to the presence of highly qualified personnel. The entire design and production cycle, from the Research & Development phase to the processing and packaging of the products, takes place in Italy, within the production plant in Osimo (AN), compliant with the most restrictive international regulations in every stage of the process, from production to marketing, pursuing the goal of continuous improvement.*

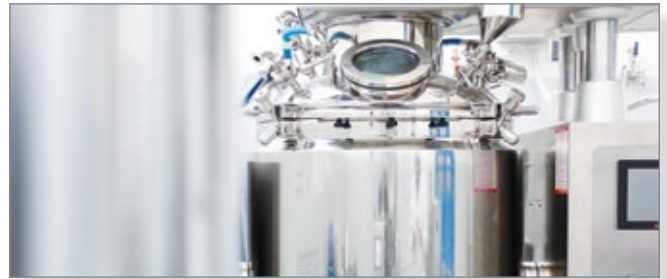

Sede Rays dedicata alla produzione cosmetica / Rays headquarters dedicated to cosmetic production

Servizio a 360 gradi per la produzione cosmetica, Private Label e contoterzi.

360 degree service for cosmetic production, private labels and third parties.

Grazie a strumenti e attrezzature di avanguardia 4.0, un team di esperti realizza costantemente linee cosmetiche personalizzate e made in Italy, seguendo ogni fase dalla ricerca e sviluppo fino alla realizzazione e promozione delle stesse.

Thanks to state-of-the-art 4.0 tools and equipment, a team of experts constantly creates customized and made in Italy cosmetic lines, following each phase from research and development to their creation and promotion.

INDICE INDEX

- 7** **Medicazione tradizionale**
Traditional dressing products
- 28** **Guanti chirurgici**
Surgical gloves
- 34** **Guanti esame**
Examination gloves
- 47** **Aghi e siringhe**
Needles and syringes
- 61** **Dispositivi per il diabete**
Devices for diabetic therapy
- 65** **Dispositivi per terapie infusionali**
Infusion therapy devices
- 76** **Terapia e Diagnostica**
Therapy and Diagnostics
- 79** **Tessuto non tessuto, prodotti per operatori sanitari**
Non-woven fabric, products for healthcare workers
- 104** **Igiene della persona - Dermalays**
Personal hygiene - Dermalays



MEDICAZIONE TRADIZIONALE *TRADITIONAL DRESSING PRODUCTS*

La gamma dei prodotti commercializzati da Rays S.p.A. comprende tutti gli articoli di medicazione tradizionale in garza di cotone e in Tessuto Non Tessuto utilizzati dagli operatori sanitari.

La linea offerta da Rays S.p.A. comprende prodotti sterili e non sterili quali: compresse di garza tagliate e piegate, in cotone e in TNT, pezzi laparotomiche, tamponi, cotone idrofilo, medicazioni adesive sterili e cerotti di fissaggio non sterili. Tutti i prodotti sono disponibili in diversi formati e confezionamenti così da consentire un utilizzo ideale nelle diverse condizioni.

The range of products offered by Rays S.p.A. includes all traditional dressing items, such as cotton gauze and non-woven products, which are used in units and operating rooms.

The product line offered by Rays S.p.A. is composed of sterile and non-sterile products, as follows: cutting and folded, cotton and non-woven gauze swabs, gauze lap sponges, gauze balls, cotton wool, sterile adhesive wound dressings and non sterile adhesive tape rolls. All products are available in different sizes and packagings, allowing an ideal use in various conditions.

COMPRESSE IN GARZA DI COTONE E IN TNT COTTON AND NON-WOVEN GAUZE SWABS

Rays S.p.A. propone una linea di garze ampia ed articolata per rispondere a tutte le esigenze che si manifestano in ambito medico-chirurgico. Nella linea troviamo le compresse di garza sterili e non sterili, tagliate e piegate.

Rays S.p.A. offers a wide and varied range of gauzes to meet all the requirements that may arise in the medical-surgical field. In the product line we find sterile, non-sterile, cutting and folded gauze swabs.



COMPRESSE DI GARZA TAGLIATA

Compresse di garza tagliate e non piegate in busta di carta, sterile

CUTTING GAUZE SWABS

Square-cut gauze swabs in paper pouch, sterile

CARATTERISTICHE TECNICHE

- + Busta in carta da 25 unità con apertura peel-open
- + Disponibile in ulteriori formati e confezionamenti
- + Conforme alla FU vigente e alla ISO 14079
- + Dispositivo Medico classe Is

TECHNICAL FEATURES

- + 25 pcs in paper pouch with peel-open
- + Further sizes and packing available on request
- + In compliance with Official Pharmacopoeia and ISO 14079
- + Medical Device class Is

Codice Product code	Dimensioni Size	Confezionamento primario Primary packaging	Cartone Carton
STERILE			
C14X3N1SZWII	10x10 cm	100 buste/box 100 pouches/box	1000 buste 1000 pouches

CE 0123

Dispositivo Medico classe Is
Medical Device class Is



STERILE EO



COMPRESSE DI GARZA PIEGATA NON STERILE

Compresse di garza piegata, in confezione di carta medica con bordi rivolti all'interno

NON STERILE FOLDED GAUZE SWABS

Folded gauze swabs, packed in paper wrapping with folded edges

CARATTERISTICHE TECNICHE

- + Confezione in carta medica
- + Disponibile in ulteriori formati, confezionamenti e strati
- + Conforme alla FU vigente e alla ISO 14079
- + Dispositivo Medico classe I

TECHNICAL FEATURES

- + Medical paper packing
- + Further sizes, packing and plies available on request
- + In compliance with Official Pharmacopoeia and ISO 14079
- + Medical Device class I



Codice Product code	Dimensioni Size	Strati Plies	Confezionamento primario Primary packaging	Cartone Carton
------------------------	--------------------	-----------------	---	-------------------

SENZA FILO DI BARIO / WITHOUT X-RAY THREAD

NON STERILE

C14X3N8NZRC	10x10 cm	8	100 pz/pacco-pcs/pack	5000 pz/pcs
C14X3N6NZRC	10x10 cm	16	100 pz/pacco-pcs/pack	5000 pz/pcs

Le dimensioni indicate fanno riferimento alla garza piegata
The indicated sizes refer to folded gauzes

CE

Dispositivo Medico classe I
Medical Device class I



COMPRESSE DI GARZA PIEGATA STERILE

Compresse di garza piegate con bordi rivolti all'interno

STERILE FOLDED GAUZE SWABS

Sterile folded gauze swabs with folded edges

CARATTERISTICHE TECNICHE

- + Busta in PE e carta medicale con apertura peel-open
- + Con e senza filo di bario
- + Con e senza doppia etichetta di controllo
- + Disponibile in ulteriori formati, confezionamenti e strati
- + Conforme alla FU vigente e alla ISO 14079

TECHNICAL FEATURES

- + PE film and medical paper pouch with peel-open
- + With and without x-ray thread
- + With and without double control label
- + Further sizes, packing and plies available
- + In compliance with Official Pharmacopoeia and ISO 14079

Codice Product code	Dimensioni Size	Strati Plies	Confezionamento primario Primary packaging	Doppia etichetta di controllo Double control label	Confezionamento secondario Secondary packaging	Cartone Carton
------------------------	--------------------	-----------------	---	---	---	-------------------

CON FILO DI BARIO / WITH X-RAY THREAD

STERILE - BUSTA DOPPIA / STERILE - DOUBLE POUCH

C06X6X6SZ13S	5x5 cm	16	10 unità/units	Si/Yes	400 pz/pcs	3200 pz/pcs
C10X6X6SZ13S	7,5x7,5 cm	16	10 unità/units	Si/Yes	400 pz/pcs	1600 pz/pcs
C11X3X6SZ13S	7x9 cm	16	10 unità/units	Si/Yes	500 pz/pcs	5000 pz/pcs
C14X3X8SZ13S	10x10 cm	8	10 unità/units	Si/Yes	500 pz/pcs	3000 pz/pcs
C14X6X6SZ13S	10x10 cm	16	10 unità/units	Si/Yes	400 pz/pcs	1600 pz/pcs
C14X3X6SZ13S	10x10 cm	16	10 unità/units	Si/Yes	500 pz/pcs	3000 pz/pcs
C16X3X8SZ13S	10x20 cm	8	10 unità/units	Si/Yes	500 pz/pcs	3000 pz/pcs
C16X3X6SZ13S	10x20 cm	16	10 unità/units	Si/Yes	500 pz/pcs	3000 pz/pcs
C06X3X8SZ12S	5x5 cm	8	5 unità/units	Si/Yes	500 pz/pcs	6000 pz/pcs
C10X3X8SZ12S	7,5x7,5 cm	8	5 unità/units	Si/Yes	500 pz/pcs	6000 pz/pcs
C14X3X8SZ12S	10x10 cm	8	5 unità/units	Si/Yes	100 pz/pcs	3000 pz/pcs
C16X3X8SZ12S	10x20 cm	8	5 unità/units	Si/Yes	100 pz/pcs	3000 pz/pcs

Le dimensioni indicate fanno riferimento alla garza piegata
The indicated sizes refer to folded gauzes

CE 0123 Dispositivo Medico classe IIa
Medical Device class IIa



Codice Product code	Dimensioni Size	Strati Plies	Confezionamento primario Primary packaging	Doppia etichetta di controllo Double control label	Confezionamento secondario Secondary packaging	Cartone Carton
------------------------	--------------------	-----------------	---	---	---	-------------------

SENZA FILO DI BARIO / WITHOUT X-RAY THREAD

STERILE - BUSTA SINGOLA / STERILE - SINGLE POUCH

C06X3N8SZGS	5x5 cm	8	5 unità/units	No	250 pz/pcs	8000 pz/pcs
C10X3N8SZGS	7,5x7,5 cm	8	5 unità/units	No	250 pz/pcs	8000 pz/pcs
C14X3N8SZGS	10x10 cm	8	5 unità/units	No	250 pz/pcs	4000 pz/pcs
C16X3N3SZGS	10x20 cm	12	5 unità/units	No	250 pz/pcs	4000 pz/pcs
C06X3N6SZGS	5x5 cm	16	5 unità/units	No	250 pz/pcs	6000 pz/pcs
C10X3N6SZGS	7,5x7,5 cm	16	5 unità/units	No	250 pz/pcs	6000 pz/pcs
C14X3N6SZGS	10x10 cm	16	5 unità/units	No	250 pz/pcs	3000 pz/pcs
C16X3N6SZGS	10x20 cm	16	5 unità/units	No	250 pz/pcs	3000 pz/pcs
C29X3N1SZGS	18x40 cm*	16	5 unità/units	No	250 pz/pcs	3000 pz/pcs
C31X3N1SZGS	36x40 cm*	20	5 unità/units	No	250 pz/pcs	3000 pz/pcs

Le dimensioni indicate fanno riferimento alla garza piegata
The indicated sizes refer to folded gauzes

*Dimensioni della garza stesa
*Dimensions of the spread gauze

CE 0123 Dispositivo Medico classe Is
Medical Device class Is



COMPRESSE DI GARZA PIEGATA

Compresse di garza piegate con bordi rivolti all'interno.

FOLDED GAUZE SWABS

Folded gauze swabs with folded edges.

CARATTERISTICHE TECNICHE

- + Busta in PE e carta medicale con apertura peel-open
- + Senza filo di bario
- + Disponibile in ulteriori formati, confezionamenti e strati
- + Conforme alla FU vigente e alla ISO 14079
- + Dispositivo Medico classe IIa

TECHNICAL FEATURES

- + PE film and medical paper pouch with peel-open
- + Without x-ray thread
- + Further sizes, packing and plies available
- + In compliance with Official Pharmacopoeia and ISO 14079.
- + Medical Device class IIa



Codice Product code	Dimensioni Size	Strati Plies	Confezionamento primario Primary packaging	Cartone Carton
------------------------	--------------------	-----------------	---	-------------------

SENZA FILO DI BARIO / WITHOUT X-RAY THREAD

STERILE - BUSTA SINGOLA / STERILE - SINGLE POUCH

C14X3N8SZGII	10x10 cm	8	5 unità/units	1600 pz/pcs
C16X3N8SZGII	10x20 cm	8	5 unità/units	600 pz/pcs
C14X3N6SZGII	10x10 cm	16	5 unità/units	1600 pz/pcs
C16X3N6SZGII	10x20 cm	16	5 unità/units	300 pz/pcs

Le dimensioni indicate fanno riferimento alla garza piegata
The indicated sizes refer to folded gauzes

CE 0123

Dispositivo Medico classe IIa
Medical Device class IIa



STERILE EO

COMPRESSE DI GARZA PIEGATA

Compresse di garza piegate con bordi rivolti all'interno in busta di carta.

FOLDED GAUZE SWABS

Folded gauze swabs in paper pouch with folded edges.



CARATTERISTICHE TECNICHE

- + Apertura peel-open - Dimensione compressa piegata: 5x9 cm
- + Busta carta da 1 unità
- + Conforme alla FU vigente e alla ISO 14079
- + Disponibile in ulteriori formati, confezionamenti e strati
- + Dispositivo Medico classe IIa

TECHNICAL FEATURES

- + Peel-open pouch - Size of folded swab: 5x9 cm
- + 1 pieces in paper pouch
- + In compliance with Official Pharmacopoeia and ISO 14079
- + Further sizes, packing and plies available on request
- + Medical Device class IIa

Codice Product code	Dimensioni garza aperta Unfolded gauze size	Dimensioni garza piegata Folded gauze size	Strati Plies	Confezionamento primario Primary packaging	Cartone Carton
------------------------	--	---	-----------------	---	-------------------

STERILE

C29X3N1SZ5II	18x40 cm	5x9 cm	16	12 pz busta PE / 12 pcs pouch PE	4800 pz/pcs
C31X3N1SZ5II	36x40 cm	5x9 cm	32	12 pz busta PE / 12 pcs pouch PE	2400 pz/pcs
C29X3N1SZ6II	18x40 cm	5x9 cm	16	100 pz/pcs box	5000 pz/pcs
C31X3N1SZ6II	36x40 cm	5x9 cm	32	100 pz/pcs box	2000 pz/pcs

CE 0123

Dispositivo Medico classe IIa
Medical Device class IIa



STERILE EO

COMPRESSE IN TNT

Compresse di tessuto non tessuto piegate, non sterile monouso.

NON WOVEN GAUZE SWABS

Non sterile disposable non-woven gauze swabs.

CARATTERISTICHE TECNICHE

- + Confezione primaria in carta medicale - 100 pezzi
- + Senza filo di bario
- + Disponibile in ulteriori formati, confezionamenti e grammature
- + Dispositivo Medico classe IIa

TECHNICAL FEATURES

- + Primary packing in medical paper - 100 pieces
- + Without x-ray thread
- + Further sizes, packing and weights available on request
- + Medical Device class IIa

Codice Product code	Dimensioni Size	Strati Plies	Confezionamento primario Primary packaging	Cartone Carton
------------------------	--------------------	-----------------	---	-------------------

SENZA FILO DI BARIO / WITHOUT X-RAY THREAD

NON STERILE NON STERILE

N06T5N4NZR	5x5 cm	4	100 unità/units	5.000 pz/pcs
N10T5N4NZR	7,5x7,5 cm	4	100 unità/units	5.000 pz/pcs
N14T5N4NZR	10x10 cm	4	100 unità/units	5.000 pz/pcs
N16T5N4NZR	10x20 cm	4	100 unità/units	2.000 pz/pcs
N06T5N4NZS	5x5 cm	4	200 unità/units	10.000 pz/pcs
N10T5N4NZS	7,5x7,5 cm	4	200 unità/units	10.000 pz/pcs
N14T5N4NZS	10x10 cm	4	200 unità/units	5.000 pz/pcs
N16T5N4NZS	10x20 cm	4	200 unità/units	2.000 pz/pcs



CE 0123 Dispositivo Medico classe IIa
Medical Device class IIa



COMPRESSE IN TNT

Compresse di tessuto non tessuto piegate, sterili, monouso.

NON WOVEN GAUZE SWABS

Sterile, disposable non-woven gauze swabs.

CARATTERISTICHE TECNICHE

- + Apertura peel-open
- + Senza filo di bario
- + 5 pezzi in busta singola
- + Disponibile in ulteriori formati, confezionamenti e grammature
- + Dispositivo Medico classe IIa

TECHNICAL FEATURES

- + Peel-open pouch
- + Without x-ray thread
- + 5 pieces in single pouch
- + Further sizes, packing and weights available on request
- + Medical Device class IIa

Codice Product code	Dimensioni Size	Strati Plies	Confezionamento primario Primary packaging	Confezionamento secondario Secondary packaging	Cartone Carton
------------------------	--------------------	-----------------	---	---	-------------------

SENZA FILO DI BARIO / WITHOUT X-RAY THREAD

STERILE - BUSTA SINGOLA / STERILE - SINGLE POUCH

N06T5N4SZG	5x5 cm	4	5 unità/units	NO	5.000 pz/pcs
N14T5N4SZG	10x10 cm	4	5 unità/units	NO	1.600 pz/pcs
N16T5N4SZG	10x20 cm	4	5 unità/units	NO	1.000 pz/pcs
N06T5N4SZGS	5x5 cm	4	5 unità/units	250 pz/pcs	3.000 pz/pcs
N10T5N4SZGS	7,5x7,5 cm	4	5 unità/units	250 pz/pcs	3.000 pz/pcs
N14T5N4SZGS	10x10 cm	4	5 unità/units	250 pz/pcs	3.000 pz/pcs
N16T5N4SZGS	10x20 cm	4	5 unità/units	250 pz/pcs	1.500 pz/pcs



CE 0123 Dispositivo Medico classe IIa
Medical Device class IIa



STERILE EO

PEZZE LAPAROTOMICHE DI GARZA GAUZE LAP SPONGES

La linea è composta da pezze laparotomiche sterili e non sterili, in tessuto di garza idrofila 100% cotone di prima qualità, di colore bianco candido, a quattro strati ripiegati e cuciti, disponibili con e senza filo di bario, con o senza laccio di reperimento.

The product line consists of sterile and non-sterile lap sponges, made of first quality, snow-white colored, 100% cotton with 4 plies folded and sewn. It is available with or without X-Ray thread and with or without loop.



PEZZE LAPAROTOMICHE CON STRATI RPIEGATI E CUCITI LAP SPONGES, PLIES FOLDED AND SEWN

CARATTERISTICHE TECNICHE

- + Con filo di bario
- + Busta peel-open in PE e carta medicale
- + 5/10 pz in busta doppia
- + 100 pz in busta singola
- + Colore bianco
- + Con e senza fettuccia di repertamento
- + Disponibile anche:
 - Con doppia etichetta di controllo
 - Senza filo di bario
 - In ulteriori formati, confezionamento e strati
- + Conforme alla FU vigente e alla ISO 14079
- + Dispositivo Medico classe IIa

TECHNICAL FEATURES

- + With x-ray thread
- + Peel-open pouch in PE film and medical paper
- + 5/10 pcs in double pouch
- + 100 pcs in single pouch
- + White color
- + With and without loop
- + Available also:
 - With double control label
 - Without x-ray thread
 - Further sizes, packing and plies
- + In compliance with Official Pharmacopoeia and ISO 14079
- + Medical Device class IIa

Codice Product code	Dimensioni Size	Strati Plies	Confezionamento primario Primary packaging	Cartone Carton
------------------------	--------------------	-----------------	---	-------------------

CON FILO DI BARIO / WITH X-RAY THREAD

CON LACCIO DI REPERTAMENTO / WITH LOOP

STERILE

P18X3X4SG12S	10x60 cm	4	5 unità/units	1500 pz/pcs
P94X3X4SG12S	20x30 cm	4	5 unità/units	1500 pz/pcs
P33X3X4SG12S	40x40 cm	4	5 unità/units	750 pz/pcs
P38X3X4SG12S	45x70 cm	4	5 unità/units	500 pz/pcs

SENZA LACCIO DI REPERTAMENTO / WITHOUT LOOP

PB5X3X4SP13II	1,5X40 cm	4	10 unità/units	3200 pz/pcs
P99X3X4SP13II	2X95 cm	4	10 unità/units	2400 pz/pcs
PF6X3X4SP13II	5X20 cm	4	10 unità/units	4000 pz/pcs
PG6X3X4SP13II	5X95 cm	4	10 unità/units	2400 pz/pcs
PG7X3X4SP13II	9X95 cm	4	10 unità/units	1600 pz/pcs
P28X3X4SP13II	4X80 cm	4	10 unità/units	2400 pz/pcs
PA4X3X4SP13II	20X80 cm	4	10 unità/units	800 pz/pcs
PF5X3X4SP12II	50X55cm	4	5 unità/units	400 pz/pcs

Prodotto non sterile disponibile su richiesta
Non sterile product available on request

Codice Product code	Dimensioni Size	Strati Plies	Confezionamento primario Primary packaging	Cartone Carton
------------------------	--------------------	-----------------	---	-------------------

CON FILO DI BARIO / WITH X-RAY THREAD

CON LACCIO DI REPERTAMENTO / WITH LOOP

NON STERILE

PA8X3X6NGM	2,5X60 cm	6	100 unità/units	2400 pz/pcs
P18X3X6NGM	10X60 cm	6	100 unità/units	2000 pz/pcs
PA9X3X6NGM	10X95 cm	6	100 unità/units	1000 pz/pcs
PB1X3X6NGM	20X90 cm	6	100 unità/units	600 pz/pcs
P33X3X6NGM	40X40 cm	6	100 unità/units	600 pz/pcs
P38X3X6NGM	45X70 cm	6	100 unità/units	400 pz/pcs
P35X3X6NGM	50X50 cm	6	100 unità/units	400 pz/pcs
PC8X3X6NGM	60X60 cm	6	100 unità/units	400 pz/pcs

Prodotto sterile disponibile su richiesta
Sterile product available on request



CE 1370

Dispositivo Medico classe IIa
Medical Device class IIa



TAMPONI DI GARZA GAUZE BALLS

La gamma comprende tamponi chirurgici rotondi di garza con e senza filo di bario, con e senza elastico, totalmente latex-free. Disponibili in diverse dimensioni e confezioni per rispondere efficacemente alle diverse necessità di utilizzo.

The product range includes surgical round gauze balls with or without x-ray thread, with or without elastic ring and totally latex free. They are available in several sizes and packaging in order to meet effectively different needs of usage.

TAMPONE DI GARZA

Tampone chirurgico rotondo di garza, con elastico latex free

GAUZE BALLS

Round gauze ball with latex-free elastic ring

CARATTERISTICHE TECNICHE

- + Con o senza filo di bario
- + 5 o 10 pezzi in busta singola/doppia, con o senza doppia etichetta
- + Buste peel open in PE e carta medicale
- + Disponibile anche:
 - Senza elastico
 - In ulteriori formati e confezionamenti
- + Conforme alla FU vigente e alla ISO 14079
- + Dispositivo Medico classe IIa

TECHNICAL FEATURES

- + With or without x-ray thread
- + 5 or 10 pieces in single/double pouch, with or without double control label
- + Peel open pouch in PE film and medical paper
- + Available also:
 - Without elastic ring
 - Further sizes and packing
- + In compliance with Official Pharmacopoeia and ISO 14079
- + Medical Device class IIa

Codice Product code	Dimensioni Size	Confezionamento primario Primary packaging	Doppia etichetta di controllo Double control label	Confezionamento secondario Secondary packaging	Cartone Carton
------------------------	--------------------	---	---	---	-------------------

CON FILO DI BARIO / WITH X-RAY THREAD

STERILE, DOPPIA BUSTA / STERILE, DOUBLE POUCH

O53X3X1SZ12	Ø 25 mm	5 unità/units	Si/Yes	NO	5000 pz/pcs
O54X3X1SZ12	Ø 30 mm	5 unità/units	Si/Yes	NO	5000 pz/pcs
OF9X3X1SZ13	Ø 9 mm	10 unità/units	Si/Yes	NO	5000 pz/pcs
O49X3X1SZ13	Ø 15 mm	10 unità/units	Si/Yes	NO	5000 pz/pcs
O52X3X1SZ13S	Ø 20 mm	10 unità/units	Si/Yes	500 pz/pcs	3000 pz/pcs
O54X3X1SZ13S	Ø 30 mm	10 unità/units	Si/Yes	200 pz/pcs	2000 pz/pcs
O56X3X1SZ13S	Ø 40 mm	10 unità/units	Si/Yes	200 pz/pcs	2000 pz/pcs
O57X3X1SZ13S	Ø 50 mm	10 unità/units	Si/Yes	200 pz/pcs	2000 pz/pcs
O58X3X1SZ13S	Ø 60 mm	10 unità/units	Si/Yes	200 pz/pcs	2000 pz/pcs

SENZA FILO DI BARIO WITHOUT X-RAY THREAD

STERILE, DOPPIA BUSTA / STERILE, DOUBLE POUCH

O54X3N1SZF	Ø 30 mm	10 unità/units	Si/Yes	NO	5000 pz/pcs
O57X3N1SZF	Ø 50 mm	10 unità/units	Si/Yes	NO	2500 pz/pcs

CE 0123 Dispositivo Medico classe IIa
Medical Device class IIa



STERILE EO

Codice Product code	Dimensioni Size	Confezionamento primario Primary packaging	Cartone Carton
------------------------	--------------------	---	-------------------

SENZA FILO DI BARIO WITHOUT X-RAY THREAD

STERILE, BUSTA SINGOLA / STERILE, SINGLE POUCH

O56X3N1SZG	Ø 40 mm	5 unità/units	2500 pz/pcs
------------	---------	---------------	-------------

CE 1370 Dispositivo Medico classe IIa
Medical Device class IIa



STERILEEO



TAMPONE DI GARZA

Tampone chirurgico rotondo di garza, con elastico latex free

GAUZE BALLS

Round gauze ball with latex-free elastic ring

CARATTERISTICHE TECNICHE

- + 100 pezzi in sacchetto di polietilene / 10 pezzi in busta singola in PE e carta medicale con indicatore di sterilità
- + Con e senza filo di bario
- + Disponibile in ulteriori formati e confezionamenti
- + Conforme alla FU vigente e alla ISO 14079
- + Dispositivo Medico classe IIa

TECHNICAL FEATURES

- + 100 pcs in PE bag / 10 pieces in single pouch in PE film and medical paper, with sterility indicator
- + With or without x-ray thread
- + Available in other sizes and packing
- + In compliance with Official Pharmacopoeia and ISO 14079
- + Medical Device class IIa



Codice Product code	Dimensioni Size	Confezionamento primario Primary packaging	Cartone Carton
------------------------	--------------------	---	-------------------

CON FILO DI BARIO / WITH X-RAY THREAD

NON STERILE

O46X3X1NYES	Ø 10 mm	10 unità/units	10000 pz/pcs
O53X3X1NYES	Ø 25 mm	10 unità/units	10000 pz/pcs
O54X3X1NYES	Ø 30 mm	10 unità/units	10000 pz/pcs
O56X3X1NYES	Ø 40 mm	10 unità/units	5000 pz/pcs
O58X3X1NYES	Ø 60 mm	10 unità/units	3000 pz/pcs

Codice Product code	Dimensioni Size	Confezionamento primario Primary packaging	Cartone Carton
------------------------	--------------------	---	-------------------

SENZA FILO DI BARIO WITHOUT X-RAY THREAD

NON STERILE

O54X3N1NZM	Ø 30 mm	100 unità/units	3500 pz/pcs
------------	---------	-----------------	-------------

CE 1370 Dispositivo Medico classe IIa
Medical Device class IIa



BENDE *BANDAGES*

I bendaggi vengono utilizzati in diversi contesti terapeutici, pertanto debbono avere caratteristiche specifiche in funzione della loro applicazione. Per rispondere in modo ottimale alle condizioni in cui il bendaggio dovrà essere applicato, la Rays S.p.A. propone diverse categorie di bende: bende elastiche di fissaggio leggero (bende tipo Ideal) oltre che le classiche bende di garza orlate. Una linea che garantisce livelli ottimali di elasticità, supporto, compressione e comfort per ogni azione terapeutica.

Bandages are used in various therapeutic contexts, therefore they should have the specific features depending on their application. In order to satisfy optimally the conditions on where the bandage should be applied, Rays S.p.A. offers various categories of bandages such as: cohesive elastic bandages, light application elastic bandages (Ideal type bandages) as well as the classic selvedge bandages. A complete line to ensure optimum level of flexibility, support, compression and comfort for every therapeutic action.



BENDA DI GARZA IDROFILA ORLATA

Benda di garza idrofila in puro cotone

SELVEDGE HYDROPHILIC GAUZE BANDAGE

Hydrophilic gauze bandage in pure cotton

CARATTERISTICHE TECNICHE

- + Composizione: 100% cotone idrofilo candido
- + Lunghezza: 5 m
- + Disponibile in altre lunghezze a richiesta
- + Confezione singola in cellophane, 10 pezzi raccolti in buste di polietilene
- + Conforme alla FU vigente
- + Dispositivo Medico classe I

TECHNICAL FEATURES

- + Composition: 100% snow-white hydrophilic cotton
- + Length: 5 m
- + Available in other lengths on request
- + Single cellophane wrapping, 10 pieces in PE bag
- + In compliance with Official Pharmacopoeia
- + Medical Device class I

Codice Product code	Altezza Height	Confezionamento primario Primary packaging	Cartone Carton
------------------------	-------------------	---	-------------------

NON STERILE

B71X3N1NZD	5 cm	10 pz/pcs	100 pz/pcs
B73X3N1NZD	7 cm	10 pz/pcs	100 pz/pcs
B75X3N1NZD	10 cm	10 pz/pcs	100 pz/pcs
B77X3N1NZD	15 cm	10 pz/pcs	100 pz/pcs
B78X3N1NZD	20 cm	10 pz/pcs	100 pz/pcs

CE Dispositivo Medico classe I
Medical Device class I



BENDA ELASTICA IDEAL

Benda elastica tipo "IDEAL"

ELASTIC BANDAGE IDEAL

Elastic Bandage "IDEAL"

CARATTERISTICHE TECNICHE

- + Colore: ecrù (anche bianco)
- + Confezione singola in cellophane, 10 pezzi raccolti in buste di polietilene
- + Disponibile in altre lunghezze a richiesta
- + Conforme alla FU vigente
- + Dispositivo Medico classe I

TECHNICAL FEATURES

- + Ecrù color (also white)
- + Single cellophane wrapping, 10 pieces in PE bag
- + Available on request in other lengths
- + In compliance with Official Pharmacopoeia
- + Medical Device class I



Codice Product code	Altezza Height	Confezionamento primario Primary packaging	Cartone Carton
------------------------	-------------------	---	-------------------

NON STERILE

E61E7N1NSV	5 cm	10 pz/pcs	600 pz/pcs
E62E7N1NSV	7 cm	10 pz/pcs	400 pz/pcs
E63E7N1NSV	8 cm	10 pz/pcs	400 pz/pcs
E64E7N1NSV	10 cm	10 pz/pcs	240 pz/pcs
E66E7N1NSV	15 cm	10 pz/pcs	200 pz/pcs
E67E7N1NSV	20 cm	10 pz/pcs	120 pz/pcs

CE  Dispositivo Medico classe I
Medical Device class I

COTONE *COTTON WOOL*

Nella linea della medicazione, Rays S.p.A. propone come materiale assorbente per la medicazione il cotone idrofilo 100% cotone conforme alla Farmacopea Ufficiale vigente, disponibile in buste sigillate e richiudibili di diversi formati.

In its product line of medical dressing, Rays S.p.A. proposes 100% hydrophilic cotton as absorbent material, in compliance with the Official Pharmacopoeia in force. They are available in different sizes of sealed and open-close bags.



COTONE IDROFILO

100% Cotone idrofilo, categoria "ORO", conforme alla Farmacopea Ufficiale vigente

HYDROPHILIC COTTON WOOL

100% hydrophilic cotton wool, cat. "GOLD", in conformity with Official Pharmacopoeia

CARATTERISTICHE TECNICHE

- + Sistema richiudibile
- + Dispositivo Medico classe I

TECHNICAL FEATURES

- + Open-close wire
- + Medical Device class I

Codice Product code	Descrizione Description	Confezionamento primario Primary packaging	Cartone Carton
NON STERILE			
C1000G	Arrotolato / Rolls	Pacchi/Bag 1 Kg	12 pacchi/bags
C500G	Arrotolato / Rolls	Pacchi/Bag 500 gr	24 pacchi/bags



CE Dispositivo Medico classe I
Medical Device class I



MEDICAZIONI ADESIVE STERILI STERILE ADHESIVE WOUND DRESSINGS

È una medicazione postoperatoria adesiva sterile in tessuto non tessuto e con compressa centrale non aderente ed ad alto potere assorbente, particolarmente indicata per l'assorbimento degli essudati e per tenere sotto controllo il microambiente di una ferita.

È disponibile nella versione con angoli arrotondati che permettono alla medicazione di non staccarsi dalla pelle.

È una medicazione adatta a tutti i tipi di pelle, comprese quelle più sensibili.

Post-surgical adhesive wound dressing is a sterile, non-adherent, non-woven dressing, with highly absorbent central pad.

It is particularly suitable for the absorption of exudates and to keep under control the micro environment of the wound. It is available in rounded corners version, in order to allow the dressing to be steady on the skin. The dressing is suitable for all skin types, including the most sensitive ones.



MEDICAZIONE IN TNT

Medicazione adesiva sterile in TNT

NON-WOVEN WOUND DRESSING

Sterile non-woven adhesive wound dressing

CARATTERISTICHE TECNICHE

- + Morbido tessuto non tessuto traspirante, spalmato con adesivo poliacrilato ipoallergenico
- + Compresa centrale assorbente in tessuto non tessuto, non aderente alla ferita
- + Radiotrasparente
- + Permeabile all'aria e al vapore acqueo
- + Pronta all'uso
- + Alta assorbenza ed eccellente adesività
- + Rimozione indolore
- + Confezionata singolarmente
- + Disponibile in altre misure
- + Dispositivo Medico classe Is

TECHNICAL FEATURES

- + Soft respirant non-woven fabric coated with polyacrylate hypoallergenic adhesive
- + Central absorbent, non-adherent pad in non-woven fabric
- + X-ray transparent
- + Permeable to water and steam
- + Ready to use
- + High absorbency and excellent adhesivity
- + Non painful removal
- + Single packaging
- + Other sizes available on request
- + Medical Device Is

Codice Product code	Dimensioni Size	Confezionamento secondario (Box) Secondary packaging (Box)	Cartone Carton
------------------------	--------------------	---	-------------------

STERILE

DRE12SBSR	5x7 cm	100 pz/pcs	1200 pz/pcs
DREG5SBSS	6x9 cm	50 pz/pcs	600 pz/pcs
DRE14SBSS	8x10 cm	50 pz/pcs	600 pz/pcs
DRE30SBSS	10x10 cm	50 pz/pcs	600 pz/pcs
DRE36SBSS	8x15 cm	50 pz/pcs	600 pz/pcs
DRE15SBSS	10x15 cm	50 pz/pcs	600 pz/pcs
DRE16SBSU	10x20 cm	25 pz/pcs	450 pz/pcs
DRE25SBSU	10x25 cm	25 pz/pcs	450 pz/pcs
DRE26SBSU	10x30 cm	25 pz/pcs	300 pz/pcs
DRE27SBSU	10x35 cm	25 pz/pcs	300 pz/pcs



CE 0123



Dispositivo Medico classe Is
Medical Device class Is



CEROTTI DI FISSAGGIO NON STERILI *NON STERILE ADHESIVE TAPE ROLLS*

I cerotti estensibili e i cerotti su rocchetto sono indicati per il fissaggio delle diverse medicazioni e l'ampia gamma offerta da Rays S.p.A. permette di scegliere il prodotto migliore a seconda dell'uso specifico e del tipo di pelle.

Extensible tape and tapes rolls are suitable for several dressings applications and the wide range offered by Rays S.p.A. allows to choose the best product according to the specific use and the type of skin.



CEROTTO ESTENSIBILE IN TESSUTO NON TESSUTO NON-WOVEN EXTENSIBLE PLASTER ROLL

CARATTERISTICHE TECNICHE

- + Adesivo ipoallergenico
- + Carta protettiva siliconata pretagliata
- + Estensibile e conformabile per seguire le parti del corpo più difficili
- + Disponibile in altre misure
- + Conforme FU vigente
- + Dispositivo Medico classe I



TECHNICAL FEATURES

- + Hypoallergenic adhesive
- + Pre-cut silicon protective paper
- + Extensible and adaptable to all parts of the body
- + Other sizes available on request
- + In compliance with Official Pharmacopoeia
- + Medical Device class I

Codice Product code	Dimensioni Size	Confezionamento primario Primary packaging	Cartone Carton
------------------------	--------------------	---	-------------------

NON STERILE

FIX07NBSP	cm 5x10 m	Box singolo/Single box	100 box
FIX08NBSP	cm 10x10 m	Box singolo/Single box	50 box
FIX09NBSP	cm 15x10 m	Box singolo/Single box	50 box
FIX10NBSP	cm 20x10 m	Box singolo/Single box	25 box



Dispositivo Medico classe I
Medical Device class I



CEROTTO DI TELA ALL'OSSIDO DI ZINCO ZINC OXYDE TAPE ROLL

CARATTERISTICHE TECNICHE

- + Adesivo ipoallergenico
- + Ossido di zinco
- + Rocchetto in plastica con alette
- + Adatto al fissaggio di medicazioni per pelli normali
- + Disponibile in altre misure
- + Conforme FU vigente
- + Dispositivo Medico classe I

TECHNICAL FEATURES

- + Hypoallergenic adhesive
- + Zinc oxyde
- + Plastic roll with wings
- + Suitable for dressings application on normal skins
- + Other sizes available on request
- + In compliance with Official Pharmacopoeia
- + Medical Device class I

Codice Product code	Dimensioni Size	Confezionamento primario Primary packaging	Cartone Carton
------------------------	--------------------	---	-------------------

NON STERILE

OXY01NBSB*	cm 1,25x5 m	24 unità/units	720 pz/pcs
OXY02NBSC*	cm 2,5x5 m	12 unità/units	480 pz/pcs
OXY04NBSD*	cm 5x5 m	6 unità/units	240 pz/pcs
OXY06NBSD*	cm 10x5 m	6 unità/units	120 pz/pcs

*Disponibile anche senza alette/Available also without wings



Dispositivo Medico classe I
Medical Device class I



CEROTTO IN TESSUTO NON TESSUTO NON-WOVEN PAPER TAPE ROLL

CARATTERISTICHE TECNICHE

- + Adesivo ipoallergenico
- + Rocchetto in plastica con alette
- + Disponibile in altre misure
- + Adatto al fissaggio di medicazioni in zone del corpo con pelle molto sensibile
- + Conforme FU vigente
- + Dispositivo Medico classe I

TECHNICAL FEATURES

- + Hypoallergenic adhesive
- + Plastic roll with wings
- + Other sizes available on request
- + Suitable for dressings application on very sensitive skin areas of the body
- + In compliance with Official Pharmacopoeia
- + Medical Device class I

Codice Product code	Dimensioni Size	Confezionamento primario Primary packaging	Cartone Carton
------------------------	--------------------	---	-------------------

NON STERILE

PAP02NBSC*	cm 2,5x5 m	12 unità/units	480 pz/pcs
PAP04NBSD*	cm 5x5 m	6 unità/units	240 pz/pcs
PAP03NBSC*	cm 2,5x9,14 m	12 unità/units	480 pz/pcs
PAP05NBSD*	cm 5x9,14 m	6 unità/units	240 pz/pcs

*Disponibile anche senza alette/Available also without wings



CEROTTO IN SETA SILK TAPE ROLL

CARATTERISTICHE TECNICHE

- + Adesivo ipoallergenico
- + Rocchetto in plastica con alette
- + Disponibile in altre misure
- + Adatto al fissaggio di medicazioni che non devono essere sostituite frequentemente
- + Conforme FU vigente
- + Dispositivo Medico classe I

TECHNICAL FEATURES

- + Hypoallergenic adhesive
- + Plastic roll with wings
- + Other sizes available on request
- + Suitable for dressings application which do not need frequent dressing changes
- + In compliance with Official Pharmacopoeia
- + Medical Device class I

Codice Product code	Dimensioni Size	Confezionamento primario Primary packaging	Cartone Carton
------------------------	--------------------	---	-------------------

NON STERILE

SIL02NBSC*	cm 2,5x5 m	12 unità/units	480 pz/pcs
SIL04NBSD*	cm 5x5 m	6 unità/units	240 pz/pcs
SIL03NBSC*	cm 2,5x9,14 m	12 unità/units	480 pz/pcs
SIL05NBSD*	cm 5x9,14 m	6 unità/units	240 pz/pcs
SIL51NBSB*	cm 1,25x9,14 m	24 unità/units	720 pz/pcs

*Disponibile anche senza alette/Available also without wings



CEROTTO IN POLIETILENE TRASPARENTE TRANSPARENT POLYETILENE TAPE ROLL

CARATTERISTICHE TECNICHE

- + Micro foratura per maggiore traspirabilità
- + Adesivo ipoallergenico
- + Rocchetto in plastica con alette
- + La trasparenza permette un frequente controllo delle medicazioni
- + Disponibile in altre misure
- + Conforme FU vigente
- + Dispositivo Medico classe I

TECHNICAL FEATURES

- + *Micro holes for better breathability*
- + *Hypoallergenic adhesive*
- + *Plastic roll with wings*
- + *The transparency permits the frequent check of the dressings*
- + *Other sizes available on request*
- + *In compliance with Official Pharmacopoeia*
- + *Medical Device class I*

Codice Product code	Dimensioni Size	Confezionamento primario Primary packaging	Cartone Carton
------------------------	--------------------	---	-------------------

NON STERILE

FIT03NTSC*	cm 2,5x9,14 m	12 unità/ <i>units</i>	480 pz/ <i>pcs</i>
FIT05NTSD*	cm 5x9,14 m	6 unità/ <i>units</i>	240 pz/ <i>pcs</i>

*Disponibile anche senza alette/*Available also without wings*



Dispositivo Medico classe I
Medical Device class I



GUANTI CHIRURGICI SURGICAL GLOVES

L'assortimento di guanti chirurgici offerto da Rays S.p.A. è frutto di anni di costante attività di ricerca e sviluppo volta alla conoscenza dell'innovazione coniugata con le esigenze degli utilizzatori. L'intera gamma ha raggiunto oggi il massimo livello di sicurezza e qualità produttiva ed è in grado di garantire l'ottimale protezione della mano dai rischi a cui è esposto l'operatore sanitario, salvaguardando le esigenze di comfort, sicurezza prensile e sensibilità tattile.

The assortment of surgical gloves offered by Rays S.p.A. is the result of years of constant research and development aimed at understanding innovation combined with user needs. The entire range has today reached the highest level of safety and production quality and is able to guarantee optimal protection of the hand from the risks to which the healthcare worker is exposed, safeguarding the needs for comfort, grip safety and tactile sensitivity.



Rays S.p.A. è partner italiano esclusivo per la commercializzazione della linea guanti chirurgici **iNtouch®**, prodotti da **KOSSAN INTERNATIONAL SDN. BHD.**, leader mondiale nella produzione di dispositivi medici in gomma naturale e sintetica.

Grazie al know how raggiunto con la sua esperienza trentennale Rays S.p.A. è in grado di offrire guanti chirurgici di prima qualità:

- In lattice identificati dai marchi **HYDROFEEL** e **FEELTOUCH**;
- In sintetici, Policloroprene e Poliisoprene caratterizzati dal marchio **ULTRAPRENE SYNTHETIC®**.

Ogni professionista del settore potrà trovare all'interno della gamma guanti chirurgici offerti da Rays S.p.A. la soluzione più idonea a soddisfare le differenti e peculiari esigenze prestazionali.

*Rays S.p.A. is the exclusive Italian partner for the commercialization of the **iNtouch®** surgical glove line, produced by **KOSSAN INTERNATIONAL SDN. BHD.**, world leader in the production of medical devices in natural and synthetic rubber.*

Thanks to the know-how achieved with its thirty years of experience Rays S.p.A. is able to offer top quality surgical gloves:

- *In latex identified by the **HYDROFEEL** and **FELTOUCH** brands;*
- *In synthetics, Polychloroprene and Polyisoprene characterized by the **ULTRAPRENE SYNTHETIC®** brand.*

Within the range of surgical gloves offered by Rays S.p.A., every professional in the sector will be able to find the most suitable solution to meet the different and peculiar performance needs.

INTOUCH® POWDER FREE - GUANTI CHIRURGICI IN LATTICE
INTOUCH® POWDER FREE - LATEX SURGICAL GLOVES

CODICE | Product code: INTW10

INTouch® POWDER FREE è il guanto chirurgico sterile in lattice di alta qualità, realizzato per chi desidera un'ottima presa degli strumenti, comfort e sicurezza. **INTouch® POWDER FREE** è completamente privo di polvere e facile da indossare grazie al rivestimento interno realizzato a base di polimeri sintetici. La forma dal design esclusivo e la garanzia di massima protezione rappresentano una efficace risposta alle esigenze in campo chirurgico.

***INTouch® POWDER FREE** is high quality, latex sterile surgical gloves designed for those who require a secure grip for instruments handling, comfort and security. **INTouch® POWDER FREE** is completely powder-free and easy to wear thanks to the inner coating based on synthetic polymers. Thanks to exclusive design and to maximum protection guaranty, they meet efficiently all the requirements of the surgical field.*



LATTICE - SENZA POLVERE

Dispositivi Medici Classe IIa
 D.P.I. di III Cat.

LATEX - POWDER FREE

Medical Device Class IIa
 P.P.E. of Cat. III

Taglie Sizes

- 5,5
- 6
- 6,5
- 7
- 7,5
- 8
- 8,5
- 9



CE 2797     **AQL 0.65**

Dispenser	Cartone Carton	Bancale Pallet
50 paia / pairs	200 paia / pairs	42 cartoni / cartons

FEELTOUCH 300PP - GUANTI CHIRURGICI IN LATTICE FEELTOUCH 300PP - LATEX SURGICAL GLOVES

FEELTOUCH

CODICE | Product code: SGA1SW

FEELTOUCH 300 PP è il guanto chirurgico sterile in lattice naturale, rivestito internamente con amido di mais modificato (USP) utilizzato come lubrificante, per facilitarne la calzatura. Offre un'eccellente combinazione di protezione, comfort e sensibilità, adattandosi perfettamente alla mano grazie alla sua elevata elasticità.



FEELTOUCH 300 PP is a natural latex sterile surgical glove, internally coated with modified cornstarch (USP) that is used as a lubricant for easy fit.

It offers an excellent combination of protection, comfort and sensibility, by fitting perfectly the hand thanks to its elasticity.

LATTICE - CON POLVERE

Dispositivi Medici Classe IIa - D.P.I. di III Cat.

LATEX - POWDERED

Medical Device Class IIa - P.P.E. of Cat. III

Taglie Sizes

5,5
6
6,5
7
7,5
8
8,5
9



CE 0465 (2) LATEX STERILE R AQL 0.65

Dispenser	Cartone Carton	Bancale Pallet
50 paia / pairs	400 paia / pairs	24 cartoni / cartons

FEELTOUCH 300PF - GUANTI CHIRURGICI IN LATTICE FEELTOUCH 300PF - LATEX SURGICAL GLOVES

FEELTOUCH

CODICE | Product code: SGB1SW

FEELTOUCH 300 PF è il guanto chirurgico di alta qualità sterile in lattice naturale senza polvere. Vestibilità e barriera protettiva sono i fattori che contribuiscono a rendere il guanto di elevata qualità. L'ottima elasticità e un'eccellente micro testurizzazione lo rendono ideale per le procedure di chirurgia generale. Il guanto offre comfort eccezionale e bassa allergenicità.



FEELTOUCH 300 PF is the high quality powder-free natural latex sterile surgical glove.

Wearability and protection are the key elements that contribute to a high quality glove. It's ideal for general surgery thanks to its excellent elasticity and micro texture. This glove offers exceptional comfort and low allergenicity.

LATTICE - SENZA POLVERE

Dispositivi Medici Classe IIa - D.P.I. di III Cat.

LATEX - POWDER FREE

Medical Device Class IIa - P.P.E. of Cat. III

Taglie Sizes

5,5
6
6,5
7
7,5
8
8,5
9



CE 0465 (2) LATEX STERILE R AQL 0.65

Dispenser	Cartone Carton	Bancale Pallet
50 paia / pairs	300 paia / pairs	36 cartoni / cartons

CODICE | Product code: SGC1SW

HYDROFEEL è il guanto chirurgico sterile in lattice di alta qualità, realizzato per chi desidera un'ottima presa degli strumenti, comfort e sicurezza. **HYDROFEEL** è completamente privo di polvere e facile da indossare grazie al rivestimento interno realizzato a base di polimeri sintetici. La forma dal design esclusivo e la garanzia di massima protezione rappresentano una efficace risposta alle esigenze in campo chirurgico.

***HYDROFEEL** is high quality, sterile latex surgical gloves designed for those who require a secure grip for instruments handling, comfort and security. **HYDROFEEL** is completely powder-free and easy to wear thanks to the inner coating based on synthetic polymers. Thanks to exclusive design and to maximum protection guaranty, they meet efficiently all the requirements of the surgical field.*



LATTICE - SENZA POLVERE

Dispositivi Medici Classe IIa - D.P.I. di III Cat.

LATEX - POWDER FREE

Medical Device Class IIa - P.P.E. of Cat. III

Taglie Sizes

- 5,5
- 6
- 6,5
- 7
- 7,5
- 8
- 8,5
- 9



Dispenser	Cartone Carton	Bancale Pallet
50 paia / pairs	400 paia / pairs	36 cartoni / cartons



ULTRAPRENE SYNTHETIC - GUANTI CHIRURGICI IN POLICLOROPRENE ULTRAPRENE SYNTHETIC - SURGICAL GLOVES IN POLYCHLOROPRENE



CODICE | Product code: SGG1ST

ULTRAPRENE SYNTHETIC è la risposta alle più rigorose esigenze in campo chirurgico. Guanto sterile, senza polvere, completamente privo di lattice, realizzato in policloroprene di colore marrone, rappresenta la soluzione per la prevenzione dalle allergie alle proteine del lattice di gomma naturale, garantendo protezione avanzata, migliore sensibilità tattile e comfort sia per i pazienti che per i professionisti della sanità. Il colore marrone permette di lavorare senza riflettere la luce e facilita la concentrazione dell'occhio sull'essenziale.



The **ULTRAPRENE SYNTHETIC** surgical glove satisfies the most rigorous requirements in the surgical field. It is a sterile glove, completely powder and latex free, in brown polychloroprene which prevents the allergies caused by natural rubber latex proteins. It guarantees enhanced security, improved tactile sensitivity and comfort both to patients and health professionals. The brown color allows you to work without reflecting light and facilitates the eye's concentration on the essentials.

POLICLOROPRENE - SENZA POLVERE

Dispositivi Medici Classe IIa - D.P.I. di III Cat.

POLYCHLOROPRENE - POWDER FREE

Medical Device Class IIa - P.P.E. of Cat. III

Taglie Sizes

5,5
6
6,5
7
7,5
8
8,5
9



Dispenser	Cartone Carton	Bancale Pallet
50 paia / pairs	200 paia / pairs	33 cartoni / cartons

ULTRAPRENE SYNTHETIC - GUANTI CHIRURGICI IN POLIISOPRENE ULTRAPRENE SYNTHETIC - SURGICAL GLOVES IN POLYISOPRENE



CODICE | Product code: SGH1SW

ULTRAPRENE SYNTHETIC - POLIISOPRENE è la risposta alle più rigorose esigenze in campo chirurgico. Guanto sterile, senza polvere, completamente privo di lattice, realizzato in poliisoprene di colore bianco, rappresenta la soluzione per la prevenzione dalle allergie alle proteine del lattice di gomma naturale, garantendo protezione avanzata, migliore sensibilità tattile e comfort sia per i pazienti che per i professionisti della sanità.



The **ULTRAPRENE SYNTHETIC - POLYISOPRENE** surgical glove satisfies the most rigorous requirements in the surgical field. It is a sterile glove, completely powder and latex free, in white polyisoprene which prevents the allergies caused by natural rubber latex proteins. It guarantees enhanced security, improved tactile sensitivity and comfort both to patients and health professionals.

POLIISOPRENE - SENZA POLVERE

Dispositivi Medici Classe IIa - D.P.I. di III Cat.

POLYISOPRENE - POWDER FREE

Medical Device Class IIa - P.P.E. of Cat. III

Taglie Sizes

5,5
6
6,5
7
7,5
8
8,5
9



Dispenser	Cartone Carton	Bancale Pallet
50 paia / pairs	200 paia / pairs	33 cartoni / cartons





www.glovely.it

GUANTI DA ESAMINAZIONE EXAMINATION GLOVES

I guanti da esame della linea **Glovely®** sono divenuti negli anni un prodotto indispensabile in tutte le attività del settore clinico. Parallelamente alla loro diffusione, sono cresciute anche le richieste degli operatori che desiderano utilizzare un prodotto funzionale alle specifiche esigenze di impiego.

Rays S.p.A. offre una gamma estremamente articolata di dispositivi differenziata per livello di protezione e comfort, per garantire il massimo livello di igiene e sicurezza sia agli operatori che ai pazienti, ma anche la totale serenità nella manipolazione di sostanze chimiche.

*The examination gloves **Glovely®** during the years have turned into an essential product in all activities connected to the medical environment. At the same time the demand of the medical staff for a functional and specific product for every need has risen.*

Rays S.p.A. offers an extremely varied range of devices differentiated by level of protection and comfort, to guarantee the maximum level of hygiene and safety for both operators and patients, but also total peace of mind when handling chemical substances.



La gamma completa *The full range*

La gamma di dispositivi medici e di dispositivi di protezione individuale monouso in nitrile è particolarmente ampia. I prodotti, tutti corrispondenti agli standard aziendali di innovazione, eccellenza e praticità, hanno differenti caratteristiche tecniche e spessori, andando incontro alle diverse esigenze del mercato.

The range of medical devices and disposable nitrile PPE is particularly wide. All the products correspond to our corporate standards of innovation, excellence and practicality. They have different technical features and thicknesses thus meeting the various market's needs.



DAR NI SILK



DAR NI FOOD



BIOSOFT FOOD



DAR NI



DAR NI BLACK



DAR NI BIO



DAR NI GOLD



DAR NI CHE



DAR NI ONE



DAR NI CHS



DAR NI ORANGE



DAR NI TECH



BIOSOFT FOOD 20



DAR NI SILK 20

Nitrile
Nitrile



DVIPF



DVELPF

Vinile
Vinyl



DAREX



DARPPFG



DARHR

Lattice
Latex



TPE200BL



E6T90

Sintetici
Synthetic

CODICE | Product code: DARNIBIO

Guanto non sterile in nitrile BIODEGRADABILE*, verde pastello, privo di lattice, senza polvere, con superficie testurizzata a diamante.

Non sterile biodegradable nitrile glove, pastel green color, latex and powder free, diamond textured surface.*

*in discariche operative attraverso un processo microbico in ambienti anaerobici.

**in operational landfills through a microbial process in anaerobic environments.*

NITRILE/NITRILE

DM Classe I
 D.P.I. di III Cat.

MD Class I
 P.P.E. of Cat. III



Taglie	Sizes
S	6-6,5
M	7-7,5
L	8-8,5
XL	9-9,5



CE 2777

AQL 0.65



Dispenser	Cartone Carton	Bancale Pallet
100 pezzi / pcs	1000 pezzi / pcs	108 cartoni / cartons

Accelerator free

Privo di sostanze acceleranti quali tiurami, carbammati e benzotiazoli, per ridurre al minimo il rischio di reazione di ipersensibilità ritardata di tipo IV.

Free from accelerating substances such as thiurams, carbamates and benzothiazoles, to minimize the risk of type IV delayed hypersensitivity reaction.

BIODEGRADABILITÀ*
 BIODEGRADABILITY*

36,7%

secondo il test ASTM D5511
 according to ASTM D5511 test



ECOGLOVELY si biodegrada* 10 volte più velocemente rispetto ai tradizionali guanti in nitrile

**in discariche operative attraverso un processo microbico in ambienti anaerobici
 ECOGLOVELY biodegrades* 10 times faster than traditional nitrile gloves*

**in operational landfills through a microbial process in anaerobic environments*

BIOSOFT PF type 30
GUANTI DA ESAMINAZIONE IN NITRILE
BIOSOFT PF type 30
NITRIL EXAMINATION GLOVES

CODICE | Product code: DARNISILK

Guanto in nitrile azzurro, privo di lattice e privo di polvere.

Vantaggi

Sensibilità, elasticità e resistenza.

Nitrile glove, light blue colour, latex and powder free.

Benefits

High sensitivity, elasticity and resistance.



NITRILE/NITRILE

DM Classe I
 D.P.I. di III Cat.

*MD Class I
 P.P.E. of Cat. III*

BOX DA 100 PEZZI/ 100 PIECES BOX

Taglie Sizes

XS	5-5,5
S	6-6,5
M	7-7,5
L	8-8,5
XL	9-9,5



CE 0465

AQL 0.65



Dispenser	Cartone Carton	Bancale Pallet
100 pezzi / pcs	1000 pezzi / pcs	84 cartoni / cartons

CODICE | Product code: DARNISILK20



BOX DA 20 PEZZI/ 20 PIECES BOX

Taglie Sizes

S	6-6,5
M	7-7,5
L	8-8,5



CE 0465

AQL 0.65



Dispenser	Cartone Carton	Bancale Pallet
20 pezzi / pcs	240 pezzi / pcs	180 cartoni / cartons

BIOSOFT PF type 35
GUANTI DA ESAMINAZIONE IN NITRILE
BIOSOFT PF type 35
NITRIL EXAMINATION GLOVES

CODICE | Product code: DARNI

Guanto in nitrile azzurro, privo di lattice, senza polvere, testurizzato sulle dita.

Vantaggi

Elevata protezione, presa sicura e massimo comfort.

Nitrile glove, light blue colour, latex and powder free with finger texturisation.

Benefits

High protection, safe grip and highest comfort.



NITRILE/NITRILE

DM Classe I
 D.P.I. di III Cat.

*MD Class I
 P.P.E. of Cat. III*

Taglie Sizes

XS	5-5,5
S	6-6,5
M	7-7,5
L	8-8,5
XL	9-9,5



CE 0465

AQL 0.65



Dispenser	Cartone Carton	Bancale Pallet
100 pezzi / pcs	1000 pezzi / pcs	84 cartoni / cartons

BIOSOFT PF black 35
GUANTI DA ESAMINAZIONE IN NITRILE
BIOSOFT PF black 35
NITRIL EXAMINATION GLOVES

CODICE | Product code: DARNIBLACK

Guanto in nitrile dal caratteristico color nero, con dita testurizzate.

Vantaggi

Ottimo grip e specifica elasticità.

Nitrile glove with distinguishing black colour, finger texturisation.

Benefits

Excellent grip and elasticity.



BIOSOFT PF type 45
GUANTI DA ESAMINAZIONE IN NITRILE
BIOSOFT PF type 45
NITRIL EXAMINATION GLOVES

CODICE | Product code: DARNIGOLD

Guanto in nitrile azzurro, di elevato spessore con dita testurizzate.

Vantaggi

Protezione sicura e massima destrezza.

Nitrile glove, light blue colour, extra thickness, finger texturisation.

Benefits

Extra protection and excellent dexterity.



NITRILE/NITRILE

DM Classe I
D.P.I. di III Cat.

*MD Class I
P.P.E. of Cat. III*

Taglie *Sizes*

XS 5-5,5
S 6-6,5
M 7-7,5
L 8-8,5
XL 9-9,5



CE 0465

AQL 0.65



Dispenser

Cartone
Carton

Bancale
Pallet

100 pezzi / pcs

1000 pezzi / pcs

84 cartoni / cartons

NITRILE/NITRILE

DM Classe I
D.P.I. di III Cat.

*MD Class I
P.P.E. of Cat. III*

Taglie *Sizes*

XS 5-5,5
S 6-6,5
M 7-7,5
L 8-8,5
XL 9-9,5



CE 0465

AQL 0.65



Dispenser

Cartone
Carton

Bancale
Pallet

100 pezzi / pcs

1000 pezzi / pcs

72 cartoni / cartons

BIOSOFT PF type 65
GUANTI DA ESAMINAZIONE IN NITRILE
BIOSOFT PF type 65
NITRIL EXAMINATION GLOVES

CODICE | Product code: DARNICHE

Guanto in nitrile azzurro, privo di lattice, senza polvere, testurizzato sulle dita con manichetta lunga.

Vantaggi

Garanzia di massima barriera e protezione anche per la manipolazione di farmaci citostatici.

Nitrile glove, light blue color, latex and powder free, with finger texturisation and long cuff.

Benefits

Guarantee of maximum barrier and protection also for the handling of cytostatic drugs.



BIOSOFT PF type 70
GUANTI DA ESAMINAZIONE IN NITRILE
BIOSOFT PF type 70
NITRIL EXAMINATION GLOVES

CODICE | Product code: DARNIONE

Guanto in nitrile azzurro, privo di polvere spessore maggiorato con superficie testurizzata.

Vantaggi

Elevata protezione, presa sicura e massimo confort.

Nitrile glove, light blue colour, powder free, extra thickness with textured surface.

Benefits

High protection, safe grip and highest comfort.



NITRILE/NITRILE

DM Classe I
 D.P.I. di III Cat.

*MD Class I
 P.P.E. of Cat. III*

Taglie	Sizes
XS	5-5,5
S	6-6,5
M	7-7,5
L	8-8,5
XL	9-9,5



CE 0465

AQL 0.65



Dispenser

Cartone
Carton

Bancale
Pallet

100 pezzi / pcs

1000 pezzi / pcs

63 cartoni / cartons

NITRILE/NITRILE

DM Classe I
 D.P.I. di III Cat.

*MD Class I
 P.P.E. of Cat. III*

Taglie	Sizes
S	6-6,5
M	7-7,5
L	8-8,5
XL	9-9,5



CE 0465

AQL 0.65



Dispenser

Cartone
Carton

Bancale
Pallet

100 pezzi / pcs

1000 pezzi / pcs

63 cartoni / cartons

BIOSOFT PF tech ORANGE
GUANTI DA ESAMINAZIONE IN NITRILE
 BIOSOFT PF tech ORANGE
 NITRIL EXAMINATION GLOVES

CODICE | Product code: DARNIORANGE

Guanto non sterile in nitrile arancione, privo di lattice, senza polvere, con superficie testurizzata a diamante.

Vantaggi

Massimo grip per una presa migliore e movimenti precisi.

Non sterile nitrile glove, orange color, latex and powder free, diamond textured surface.

Benefits

Maximum grip for better grip and precise movements.



Superficie testurizzata a diamante arancione
Orange diamond textured surface

BIOSOFT PF tech BLACK
GUANTI DA ESAMINAZIONE IN NITRILE
 BIOSOFT PF tech BLACK
 NITRIL EXAMINATION GLOVES

CODICE | Product code: DARNITECH

Guanto non sterile in nitrile nero, privo di lattice, senza polvere, con superficie testurizzata a diamante.

Vantaggi

Massimo grip per una presa migliore e movimenti precisi.

Non sterile nitrile glove, black color, latex and powder free, diamond textured surface.

Benefits

Maximum grip for better grip and precise movements.



Superficie testurizzata a diamante nera
Black diamond textured surface

NITRILE/NITRILE

DM Classe I
 D.P.I. di III Cat.

*MD Class I
 P.P.E. of Cat. III*

Taglie	Sizes
S	6-6,5
M	7-7,5
L	8-8,5
XL	9-9,5



NITRILE/NITRILE

DM Classe I
 D.P.I. di III Cat.

*MD Class I
 P.P.E. of Cat. III*

Taglie	Sizes
S	6-6,5
M	7-7,5
L	8-8,5
XL	9-9,5



CE 2777

AQL 0.65



Dispenser

Cartone
 Carton

Bancale
 Pallet

50 paia / pairs

500 pezzi / pcs

63 cartoni / cartons

CE 2777

AQL 0.65



Dispenser

Cartone
 Carton

Bancale
 Pallet

50 paia / pairs

500 pezzi / pcs

63 cartoni / cartons

BIOSOFT PF cobalt FOOD
GUANTI DA ESAMINAZIONE IN NITRILE
BIOSOFT PF cobalt FOOD
NITRIL EXAMINATION GLOVES

CODICE | Product code: DARNIFOOD

Guanto in nitrile blu cobalto, privo di lattice, senza polvere, testurizzato sulle dita.

Vantaggi

Sensibilità, elevata protezione, massimo comfort.

Nitrile cobalt blue glove, latex and powder free with finger texturisation.

Benefits

High sensitivity, high protection and highest comfort.



BIOSOFT PF black FOOD
GUANTI DA ESAMINAZIONE IN NITRILE
BIOSOFT PF black FOOD
NITRIL EXAMINATION GLOVES

CODICE | Product code: BIOSOFTFOOD

Guanto in nitrile nero, privo di lattice, senza polvere, testurizzato sulle dita.

Vantaggi

Sensibilità, elevata protezione, massimo comfort.

Nitrile black glove, latex and powder free with finger texturisation.

Benefits

High sensitivity, high protection and highest comfort.



NITRILE/NITRILE

DM Classe I
 D.P.I. di III Cat.

MD Class I
 P.P.E. of Cat. III

BOX DA 100 PEZZI/ 100 PIECES BOX

Taglie	Sizes
XS	5-5,5
S	6-6,5
M	7-7,5
L	8-8,5
XL	9-9,5



CE 0465

AQL 0.65



Dispenser	Cartone Carton	Bancale Pallet
-----------	-------------------	-------------------

100 pezzi / pcs

1000 pezzi / pcs

84 cartoni / cartons

NITRILE/NITRILE

DM Classe I
 D.P.I. di III Cat.

MD Class I
 P.P.E. of Cat. III

Taglie	Sizes
XS	5-5,5
S	6-6,5
M	7-7,5
L	8-8,5
XL	9-9,5



CE 0465

AQL 0.65



Dispenser	Cartone Carton	Bancale Pallet
-----------	-------------------	-------------------

100 pezzi / pcs

1000 pezzi / pcs

84 cartoni / cartons

CODICE | Product code: BIOSOFTFOOD20



BOX DA 20 PEZZI/ 20 PIECES BOX

Taglie	Sizes
S	6-6,5
M	7-7,5
L	8-8,5



CE 0465

AQL 0.65



Dispenser	Cartone Carton	Bancale Pallet
-----------	-------------------	-------------------

20 pezzi / pcs

240 pezzi / pcs

180 cartoni / cartons

BIOSAFE PP type 50
GUANTI DA ESAMINAZIONE IN LATTICE
BIOSAFE PP type 50
LATEX EXAMINATION GLOVES

CODICE | Product code: DAREX

Guanto in lattice con polvere, con spessore ottimale e superficie liscia.

Vantaggi

Massima elasticità e comfort.

Latex powdered glove, optimal thickness and smooth surface.

Benefits

Maximum elasticity and comfort.



BIOSAFE PP type 60
GUANTI DA ESAMINAZIONE IN LATTICE
BIOSAFE PP type 60
LATEX EXAMINATION GLOVES

CODICE | Product code: DARPFG

Guanto in lattice senza polvere lubrificante, superficie testurizzata.

Vantaggi

Elevata elasticità, ottimo grip e comfort.

Latex powder free glove, textured surface.

Benefits

Highest elasticity, excellent grip and comfort.



LATTICE/LATEX

DM Classe I
D.P.I. di III Cat.

*MD Class I
P.P.E. of Cat. III*

Taglie	Sizes
XS	5-5,5
S	6-6,5
M	7-7,5
L	8-8,5
XL	9-9,5



CE 0465

AQL 0.65



Dispenser

Cartone
Carton

Bancale
Pallet

100 pezzi / pcs

1.000 pezzi / pcs

72 cartoni / cartons

LATTICE/LATEX

DM Classe I
D.P.I. di III Cat.

*MD Class I
P.P.E. of Cat. III*

Taglie	Sizes
XS	5-5,5
S	6-6,5
M	7-7,5
L	8-8,5
XL	9-9,5



CE 0465

AQL 0.65



Dispenser

Cartone
Carton

Bancale
Pallet

100 pezzi / pcs

1.000 pezzi / pcs

72 cartoni / cartons

BIOSAFE PF high RISK
GUANTI DA ESAMINAZIONE IN LATTICE
BIOSAFE PF high RISK
LATEX EXAMINATION GLOVES

CODICE | Product code: DARHR

Guanto in lattice con elevato spessore, colore blu scuro e manichetta lunga 300 mm.

Vantaggi

Massima protezione e resistenza in situazione ad alto rischio.

Latex glove, higher thickness, dark blue colour and 300 mm cuff.

Benefits

Maximum protection and resistance in high risk situations.



LATTICE/LATEX

DM Classe I
 D.P.I. di III Cat.

*MD Class I
 P.P.E. of Cat. III*

Taglie	Sizes
XS	5-5,5
S	6-6,5
M	7-7,5
L	8-8,5
XL	9-9,5
XXL	10-10,5



CE 0465

AQL 0.65



Dispenser	Cartone Carton	Bancale Pallet
50 pezzi / pcs	500 pezzi / pcs	42 cartoni / cartons

VINYL PF type 45
GUANTI DA ESAMINAZIONE IN VINILE
 VINYL PF type 45
 VINYL EXAMINATION GLOVES

CODICE | Product code: DVIPF

Guanto in vinile senza polvere lubrificante, colore bianco trasparente.

Vantaggi

Protezione e comfort.

Clear vinyl powder free glove, transparent white colour.

Benefits

Protection and dexterity.



VINYL PF type 50
GUANTI DA ESAMINAZIONE IN VINILE
 VINYL PF type 50
 VINYL EXAMINATION GLOVES

CODICE | Product code: DVELPF

Guanto in vinile elasticizzato senza polvere lubrificante, color crema, superficie liscia, elevata resistenza.

Vantaggi

Elasticità e comfort.

Stretch vinyl powder free glove, cream colour, smooth surface, high resistance.

Benefits

Elasticity and comfort.



VINILE/VINYL

DM Classe I
 D.P.I. di III Cat.

*MD Class I
 P.P.E. of Cat. III*

Taglie	Sizes
XS	5-5,5
S	6-6,5
M	7-7,5
L	8-8,5
XL	9-9,5



Colore
 Colour

VINILE/VINYL

DM Classe I
 D.P.I. di III Cat.

*MD Class I
 P.P.E. of Cat. III*

Taglie	Sizes
XS	5-5,5
S	6-6,5
M	7-7,5
L	8-8,5
XL	9-9,5



Colore
 Colour

CE 0465

AQL 0.65



Dispenser

Cartone
 Carton

Bancale
 Pallet

100 pezzi / pcs

1000 pezzi / pcs

88 cartoni / cartons

CE 0465

AQL 0.65



Dispenser

Cartone
 Carton

Bancale
 Pallet

100 pezzi / pcs

1000 pezzi / pcs

88 cartoni / cartons

TPEGLOW PF blue 20
GUANTI DA ESAMINAZIONE IN TPE
TPEGLOW PF blue 20
TPE EXAMINATION GLOVES

CODICE | Product code: TPE200BL

Guanto in TPE (elastomero termoplastico) senza polvere lubrificante, superficie liscia.

Vantaggi

Massima elasticità, elevata resistenza.

TPE (thermoplastic elastomer) powder free glove, smooth surface.

Benefits

Highest elasticity, high resistance.



HDPE
GUANTI DA ESAMINAZIONE IN POLIETILENE
HDPE
POLYETHYLENE EXAMINATION GLOVES

CODICE | Product code: E6T90

Guanto monouso in polietilene High Density, senza lattice, senza polvere, non sterile, colore trasparente, ambidestro.

Vantaggi

Superficie gofrata e facile calzabilità.

Disposable High density polyethylene glove, latex free, non sterile, powder free. Transparent color, ambidextrous.

Benefits

Embossed surface and easy fit.



TPE - ELASTOMERO TERMOPLASTICO
TPE - THERMOPLASTIC ELASTOMER

D.P.I. di I Cat.

P.P.E. of Cat. I

Taglie *Sizes*
 S/M 6-7,5
 M/L 7-8,5
 L/XL 8-9,5



Dispenser	Cartone Carton	Bancale Pallet
200 pezzi / pcs	2.000 pezzi / pcs	72 cartoni / cartons

POLIETILENE ALTA DENSITÀ
HIGH DENSITY POLYETHYLENE

D.P.I. di I Cat.

P.P.E. of Cat. I

Taglie *Sizes*
 Taglia unica
 One size



Dispenser	Cartone Carton	Bancale Pallet
100 pezzi / pcs	10.000 pezzi / pcs	72 cartoni / cartons



AGHI E SIRINGHE NEEDLES AND SYRINGES

La gamma di aghi e siringhe proposta da Rays S.p.A., rappresenta il risultato di un impegno costante, profuso negli anni dall'Azienda, per fornire soluzioni efficaci ed innovative nella somministrazione dei farmaci. Un'ampia offerta di prodotti, classificati come dispositivi medici di classe IIa, che comprende siringhe con e senza ago, siringhe da insulina, aghi ipodermici ed epicranici. Tutti i prodotti sono confezionati singolarmente in blister con apertura peel open, per garantire praticità, sterilità ed impermeabilità.

La protezione degli operatori è oggi un tema di forte interesse verso il quale i professionisti del settore ed il legislatore stanno dedicando maggiore attenzione. Rays è in grado di rispondere alle istanze più attuali provenienti dal mondo medico, offrendo anche aghi e siringhe di sicurezza.

The range of needles and syringes proposed by Rays S.p.A. is the result of a constant commitment over the years, to provide effective and innovative solutions for the drug administration.

A wide range of products, classified as medical devices of Class IIa, includes syringes with needle and without needle, insulin syringes, hypodermic needles and scalp vein sets. In order to ensure maximum practicality and secure use for the sterility and impermeability, all the products are packed in individual single blister with the peel opening system.

Protection for medical staff is one of the key subjects both healthcare professionals and legislator are focusing on nowadays. Rays is able to fulfill all latest requirements of the healthcare world, by offering both safety needles and safety syringes.

INJ/SAFE SIRINGHE CON AGO IPODERMICO DI SICUREZZA MONTATO
INJ/SAFE SYRINGES WITH MOUNTED SAFETY HYPODERMIC NEEDLE



Codice Product code	Capacità Capacity	Ago assemblato Assembled needle	Colore Colour	Box/Cartone Box/Carton
------------------------	----------------------	------------------------------------	------------------	---------------------------

CONO LUER CENTRALE / CENTRIC LUER CONE

S-1125CS16	1 ml	25G - 0,5 x 16 mm	●	100/800 pz/pcs
S-2522CS32	2,5 ml	22G - 0,7 x 32mm	●	100/800 pz/pcs
S-5522CS32	5 ml	22G - 0,7 x 32mm	●	100/800 pz/pcs
S-1022CS32	10 ml	22G - 0,7 x 32mm	●	50/400 pz/pcs
S-1021CS38	10 ml	21G - 0,8 x 38 mm	●	50/400 pz/pcs
S-2021CS38	20 ml	21G - 0,8 x 38 mm	●	50/400 pz/pcs

CARATTERISTICHE TECNICHE

- + L'ago è parte solidale ed integrante del dispositivo di sicurezza.
- + Cappuccio di sicurezza in codice colore.
- + Dispositivo di sicurezza attivabile con una sola mano.
- + Aggancio irreversibile dell'ago al meccanismo di sicurezza
- + Smussatura dell'ago orientata verso il cappuccio di sicurezza, indicando il verso di effettuazione dell'iniezione e rendendo la stessa meno traumatica.

TECHNICAL FEATURES

- + The needle is an integral part of the safety device
- + Safety cap in color code.
- + Safety device that can be activated with one hand.
- + Irreversible lock of the needle to the safety cap.
- + Needle bevel oriented to the safety cap, indicating the injection orientation and making it atraumatic.

CE 0123

Dispositivo Medico classe IIa
 Medical Device class IIa



STERILE EO

ISTRUZIONI PER L'ATTIVAZIONE DEL MECCANISMO DI SICUREZZA
INSTRUCTIONS FOR ACTIVATING THE SAFETY MECHANISM

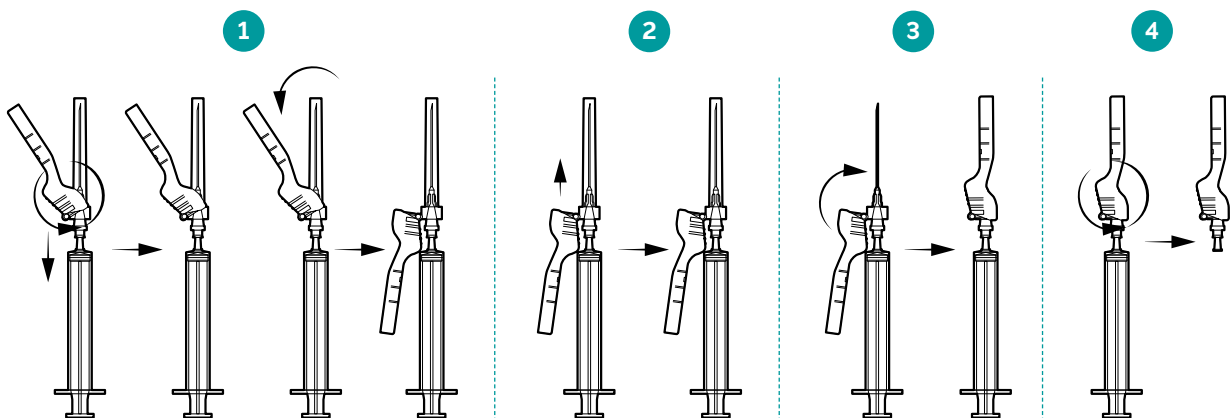

1. Abbassare il dispositivo di protezione spingendolo lateralmente.
2. Sfilare il cappuccio copri-ago e procedere con la somministrazione.
3. Al termine, sollevare il dispositivo di protezione fino a coprire interamente l'ago, avvertendo un click di aggancio. In questo modo l'ago è stato agganciato irreversibilmente.
4. Rimuovere l'ago messo in sicurezza e smaltire secondo le normative vigenti.

1. Pull down the safety cap pushing it on the side.
2. Remove the needle cap and go on with the administration.
3. After finishing, put up the protection device until the needle has been completely covered and a "click" is heard. It means that the device has been locked irreversibly.
4. Remove the safely closed needle from the syringe cone and dispose of it properly.



INJ/LIGHT® SIRINGHE IPODERMICHE 3 PARTI CON E SENZA AGO
HYPODERMIC SYRINGES IN 3 PARTS WITH AND WITHOUT NEEDLE INJ/LIGHT®

Rays S.p.A. ha investito in ricerche e sviluppo per offrire dispositivi medici di alta qualità che assicurano un livello ottimale di sicurezza.

La gamma di siringhe ipodermiche INJ/LIGHT®, fabbricata nel rispetto dei più importanti standard internazionali, è completamente atossica ed apirogena, realizzata in polipropilene trasparente con scala graduata di colore nero, confezionata in blister singolarmente. Gli aghi sono in acciaio inox AISI 304 con triplice affilatura.

Rays S.p.A. invested in research and development in order to offer high-quality medical devices that ensure an optimal level of security.

The range of Hypodermic syringes INJ/LIGHT® have been manufactured in compliance with the most important international standards, is completely non-toxic and non-pyrogenic, it is made of transparent polypropylene with graduated black colour scale and packed individually in blister packs. The needles are in stainless steel AISI 304 with triple beveling.

Codice Product code	Capacità Capacity	Ago assemblato Assembled needle	Colore Colour	Box/Cartone Box/Carton
------------------------	----------------------	------------------------------------	------------------	---------------------------

CON AGO ASSEMBLATO
WITH ASSEMBLED NEEDLE

CONO LUER CENTRALE / CENTRIC LUER CONE

2521CM38	2,5 ml	21G - 0,8x38 mm	●	100/800 pz/pcs
2522CM32	2,5 ml	22G - 0,7x32 mm	●	100/800 pz/pcs
2523CM25	2,5 ml	23G - 0,6x25 mm	●	100/800 pz/pcs
2565CM30	2,5 ml	23G - 0,65x30 mm	●	100/800 pz/pcs
5521CM38	5 ml	21G - 0,8x38 mm	●	100/800 pz/pcs
5522CM32	5 ml	22G - 0,7x32 mm	●	100/800 pz/pcs
5523CM25	5 ml	23G - 0,6x25 mm	●	100/800 pz/pcs
5565CM30	5 ml	23G - 0,65x30 mm	●	100/800 pz/pcs
1021CM38	10 ml	21G - 0,8x38 mm	●	100/800 pz/pcs
1022CM32	10 ml	22G - 0,7x32 mm	●	100/800 pz/pcs
1022CM40	10 ml	22G - 0,7x40 mm	●	100/800 pz/pcs
2020CM38	20 ml	20G - 0,9x38 mm	●	50/400 pz/pcs
2021CM38	20 ml	21G - 0,8x38 mm	●	50/400 pz/pcs

CONO LUER ECCENTRICO / ECCENTRIC LUER CONE

1021EM38	10 ml	21G - 0,8x38 mm	●	100/800 pz/pcs
2020EM38	20 ml	20G - 0,9x38 mm	●	50/400 pz/pcs
2021EM38	20 ml	21G - 0,8x38 mm	●	50/400 pz/pcs

TUBERCOLINA A RIDOTTO SPAZIO NULLO
TUBERCULIN WITH REDUCED NULL SPACE

CONO LUER CENTRALE / CENTRIC LUER CONE

TUB1ML25G16	1 ml	25G - 0,5x16 mm	●	100/800 pz/pcs
TUB1ML26G13	1 ml	26G - 0,45x12,7 mm	●	100/800 pz/pcs
TUB1ML27G13	1 ml	27G - 0,4x12,7 mm	●	100/800 pz/pcs



CE 0123

Dispositivo Medico classe IIa
 Medical Device class IIa



STERILE EO

Codice Product code	Capacità Capacity	Box/Cartone Box/ Carton
------------------------	----------------------	----------------------------

SENZA AGO ASSEMBLATO
WITHOUT ASSEMBLED NEEDLE

CONO LUER LOCK / LUER LOCK CONE

11LL	1 ml	100/800 pz/pcs
33LL	3 ml	100/800 pz/pcs
55LL	5 ml	100/800 pz/pcs
10LL	10 ml	100/800 pz/pcs
20LL	20 ml	50/400 pz/pcs
30LL	30 ml	50/400 pz/pcs
60LL	60 ml	25/200 pz/pcs

CONO LUER CENTRALE / CENTRIC LUER CONE

22LC	2 ml	100/800 pz/pcs
33LC	3 ml	100/800 pz/pcs
55LC	5 ml	100/800 pz/pcs
10LC	10 ml	100/800 pz/pcs
20LC	20 ml	50/400 pz/pcs

CONO LUER ECCENTRICO / ECCENTRIC LUER CONE

55LE	5 ml	100/800 pz/pcs
10LE	10 ml	100/800 pz/pcs
20LE	20 ml	50/400 pz/pcs
30LE	30 ml	50/400 pz/pcs
60LE	60 ml	25/200 pz/pcs

CONO CATETERE / CATHETER CONE

60CC	60 ml	20/240 pz/pcs
100CC	100 ml	25/100 pz/pcs

TUBERCOLINA A RIDOTTO SPAZIO NULLO
TUBERCULIN WITH REDUCED NULL SPACE

CONO LUER CENTRALE / CENTRIC LUER CONE

TUB1ML	1 ml	100/800 pz/pcs
--------	------	----------------

SIRINGHE IPODERMICHE 3 PARTI
SENZA AGO, AMBRATE*

HYPODERMIC SYRINGES IN 3 PARTS
*WITHOUT NEEDLE LIGHT SENSITIVE**

CONO LUER LOCK* / LUER LOCK CONE*

50LLFT*	50 ml	25/200 pz/pcs
---------	-------	---------------

***Per iniezioni e infusioni di sostanze fotosensibili**

**Intended to be used for light sensitive substances infusion*



CE 0123

Dispositivo Medico classe IIa
Medical Device class IIa



STERILE EO

INSU/LIGHT® SIRINGHE PER INSULINA INSULIN SYRINGES INSU/LIGHT®

Rays S.p.A. presenta la linea di siringhe da insulina INSU/LIGHT®, in grado di far fronte in maniera ottimale a tutte le esigenze che si manifestano nelle terapie di iniezioni di insulina. Disponibili sia nella versione con ago assemblato che in quella con ago termosaldato, entrambe a spazio nullo. Le siringhe da insulina "con spazio nullo", dove l'ago è direttamente fissato sul corpo della siringa, rendendo nullo lo spazio residuo, si presentano col doppio cappuccio protettivo (copri ago e copri asta), garantendo la sterilità del dispositivo. La linea INSU/LIGHT® è completamente atossica e apirogena, realizzata in polipropilene trasparente con scala graduata per insulina da 100 U.I., dotata di ago in acciaio inox AISI 304 con triplice affilatura.

Rays S.p.A. pone grande attenzione nei confronti delle confezioni, selezionando materiali robusti di alta qualità che assicurano un'ottimo effetto barriera ed elevata resistenza alla rottura. La grafica è stata appositamente studiata per rendere la confezione facilmente fruibile al fine di cogliere le informazioni in modo immediato.



Doppio cappuccio protettivo, garanzia di sterilità.
Double protective cap, warranty of sterility.

Rays S.p.A. represents the insulin syringes line INSU/LIGHT® in such a great way, so that can cope with all the demands that may occur during insulin injection therapies. Available with assembled needle and fixed needle version, both with no-dead space. Insulin syringes with fixed needle, where the needle is directly fixed on the cone, have a double protection (needle cap and plunger cap) assuring the sterility of the device. The INSU/LIGHT® line is completely non-toxic and non-pyrogenic, and it is made of transparent polypropylene with graduated insulin scale 100 U.I. The needle is made of stainless steel AISI304 with triple bevelling.

Rays S.p.A. pays great attention to the packaging selecting the high quality durable materials that ensure an excellent barrier effect and high resistance to the breakage. The graphics have been especially designed to render the packaging easily accessible and to capture the information immediately.

Codice Product code	Capacità Capacity	Box/Carlone Box/Carlton
------------------------	----------------------	----------------------------

A RIDOTTO SPAZIO NULLO SENZA AGO ASSEMBLATO WITH REDUCED NULL SPACE WITHOUT ASSEMBLED NEEDLE

BLISTER SINGOLO / INDIVIDUAL BLISTER PACK

INS1ML	1 ml	100/800 pz/pcs
--------	------	----------------

Codice Product code	Capacità Capacity	Ago assemblato Assembled needle	Colore Colour	Box/Carlone Box/Carlton
------------------------	----------------------	------------------------------------	------------------	----------------------------

A RIDOTTO SPAZIO NULLO CON AGO ASSEMBLATO WITH REDUCED NULL SPACE AND ASSEMBLED NEEDLE

BLISTER SINGOLO / INDIVIDUAL BLISTER PACK

INS1ML25G16	1 ml	25G - 0,5x16 mm	●	100/800 pz/pcs
INS1ML26G13	1 ml	26G - 0,45x12,7 mm	●	100/800 pz/pcs
INS1ML27G13	1 ml	27G - 0,4x12,7 mm	●	100/800 pz/pcs
INS1ML28G13	1 ml	28G - 0,36x12,7 mm	●	100/800 pz/pcs
INS1ML29G13	1 ml	29G - 0,33x12,7 mm	●	100/800 pz/pcs

Codice Product code	Capacità Capacity	Ago fisso Fixed needle	Box/Carlone Box/Carlton
------------------------	----------------------	---------------------------	----------------------------

SPAZIO NULLO CON AGO TERMOSALDATO NO-DEAD SPACE WITH FIXED NEEDLE

BLISTER SINGOLO / INDIVIDUAL BLISTER PACK

SU3-29G13	0,3 ml	29G - 0,33x12,7 mm	100/800 pz/pcs
SU3-30G08	0,3 ml	30G - 0,3x8 mm	100/800 pz/pcs
SU5-29G13	0,5 ml	29G - 0,33x12,7 mm	100/800 pz/pcs
SU5-30G08	0,5 ml	30G - 0,3x8 mm	100/800 pz/pcs
SU5-30G13	0,5 ml	30G - 0,3x13 mm	100/800 pz/pcs
SU1-25G16	1 ml	25G - 0,5x16 mm	100/800 pz/pcs
SU1-29G13	1 ml	29G - 0,33x12,7 mm	100/800 pz/pcs
SU1-30G08	1 ml	30G - 0,3x8 mm	100/800 pz/pcs

CE 0123

Dispositivo Medico classe IIa
Medical Device class IIa



STERILE EO



MICROTIP/SAFE AGHI IPODERMICI DI SICUREZZA MICROTIP/SAFE SAFETY HYPODERMIC NEEDLES



Codice Product code	Ago Needle	Colore Colour	Box/Cartone Box/Carton
S-HN16G38	16G-1,6x38mm	○	100/2500 pz/pcs
S-HN18G38	18G-1,2x38 mm	●	100/2500 pz/pcs
S-HN19G38	19G-1,1x38 mm	●	100/2500 pz/pcs
S-HN19G25	19G-1,1x25 mm	●	100/2500 pz/pcs
S-HN20G38	20G-0,9x38 mm	●	100/2500 pz/pcs
S-HN20G25	20G-0,9x25 mm	●	100/2500 pz/pcs
S-HN21G38	21G-0,8x38 mm	●	100/2500 pz/pcs
S-HN21G25	21G-0,8x25 mm	●	100/2500 pz/pcs
S-HN22G32	22G-0,7x32 mm	●	100/2500 pz/pcs
S-HN22G38	22G-0,7x38 mm	●	100/2500 pz/pcs
S-HN23G25	23G-0,6x25 mm	●	100/2500 pz/pcs
S-HN65G30	23G-0,65x30 mm	●	100/2500 pz/pcs
S-HN25G16	25G-0,5x16 mm	●	100/2500 pz/pcs
S-HN25G25	25G-0,5x25 mm	●	100/2500 pz/pcs
S-HN26G13	26G-0,45x12,7 mm	●	100/2500 pz/pcs
S-HN26G16	26G-0,45x16 mm	●	100/2500 pz/pcs
S-HN27G13	27G-0,4x12,7 mm	●	100/2500 pz/pcs
S-HN27G40	27G-0,4x40 mm	●	100/2500 pz/pcs

CE 0123

Dispositivo Medico classe IIa
Medical Device class IIa



STERILE EO

CARATTERISTICHE TECNICHE

- + Ago fisso, che è parte integrante e solidale del dispositivo di sicurezza.
- + Cappuccio di sicurezza con meccanismo facile da attivare con la mano, evitando qualunque contatto con l'ago dopo il suo utilizzo.

TECHNICAL FEATURES

- + Fixed needle, which is an integral part of the safety device.
- + Safety cap with mechanism that is easy to activate by hand, avoiding any contact with the needle after its use.

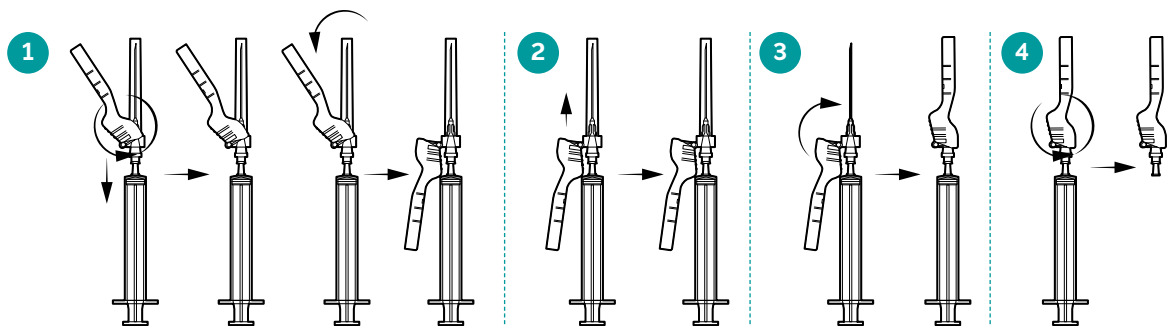

1. Abbassare il dispositivo di protezione spingendolo lateralmente.
2. Sfilare il cappuccio copri-ago e procedere con la somministrazione.
3. Al termine, sollevare il dispositivo di protezione fino a coprire interamente l'ago, avvertendo un click di aggancio. In questo modo l'ago è stato agganciato irreversibilmente.
4. Rimuovere l'ago messo in sicurezza e smaltire secondo le normative vigenti.

1. Pull down the safety cap pushing it on the side.
2. Remove the needle cap and go on with the administration.
3. After finishing, put up the protection device until the needle has been completely covered and a "click" is heard. It means that the device has been locked irreversibly.
4. Remove the safely closed needle from the syringe cone and dispose of it properly.

ISTRUZIONI D'USO INSTRUCTIONS FOR USE

MICROTIP/ULTRA® AGHI IPODERMICI MICROTIP/ULTRA® HYPODERMIC NEEDLES

Dall'esperienza Rays® nasce la linea di aghi ipodermici che, grazie alla triplice affilatura, assicurano la riduzione al minimo dei traumi durante la penetrazione. Ogni elemento dell'ago è trattato in modo specifico per un'iniezione indolore. Gli aghi sono in acciaio inox AISI 304 con triplice affilatura, totalmente atossici ed apirogeni, con cono in codice colore per una rapida identificazione della misura dell'ago.

La linea di aghi ipodermici è confezionata in blister singoli e in pratici box che ne consentono un facile prelievo ed una buona conservazione.

From Rays® experience borrows out the hypodermic needles' range which, thanks to the triple beveling, ensure to minimize trauma during their penetration. Each element of the needle is treated in a specific way for painless injection. The needles are in stainless steel AISI 304 with triple beveling, totally non-toxic and non-pyrogenic, with their cone in color code for an easy needle size identification.

The line of hypodermic needles are packaged in individual blisters and in practical boxes that will permit an easy pick up and a proper preservation.



Codice Product code	Ago Needle	Colore Colour	Box/Cartone Box/ Carton
BLISTER SINGOLO / INDIVIDUAL BLISTER PACK			
HN16G40	16G - 1,6x40 mm	○	100/3000 pz/pcs
HN18G38	18G - 1,2x38 mm	●	100/3000 pz/pcs
HN19G25	19G - 1,1x25 mm	●	100/3000 pz/pcs
HN19G38	19G - 1,1x38 mm	●	100/3000 pz/pcs
HN20G25	20G - 0,9x25 mm	●	100/3000 pz/pcs
HN20G38	20G - 0,9x38 mm	●	100/3000 pz/pcs
HN21G25	21G - 0,8x25 mm	●	100/3000 pz/pcs
HN21G38	21G - 0,8x38 mm	●	100/3000 pz/pcs
HN21G50	21G - 0,8x50 mm	●	100/3000 pz/pcs
HN22G30	22G - 0,7x30 mm	●	100/3000 pz/pcs
HN22G32	22G - 0,7x32 mm	●	100/3000 pz/pcs
HN22G38	22G - 0,7x38 mm	●	100/3000 pz/pcs
HN22G40	22G - 0,7x40 mm	●	100/3000 pz/pcs
HN22G50	22G - 0,7x50 mm	●	100/3000 pz/pcs
HN23G25	23G - 0,6x25 mm	●	100/3000 pz/pcs
HN65G30	23G - 0,65x30 mm	●	100/3000 pz/pcs
HN25G16	25G - 0,5x16 mm	●	100/3000 pz/pcs
HN25G25	25G - 0,5x25 mm	●	100/3000 pz/pcs
HN26G13	26G - 0,45x12,7 mm	●	100/3000 pz/pcs
HN27G13	27G - 0,4x12,7 mm	●	100/3000 pz/pcs
HN27G20	27G-0,4x20 mm	●	100/3000 pz/pcs
HN27G40	27G-0,4x40 mm	●	100/3000 pz/pcs
HN29G13	29G - 0,33x12,7 mm	●	100/3000 pz/pcs
HN30G08	30G - 0,30x8 mm	●	100/3000 pz/pcs
HN30G13	30G - 0,3x13 mm	●	100/3000 pz/pcs

CE 0123

Dispositivo Medico classe IIa
Medical Device class IIa



STERILE/EO

FLY/SAFE - AGHI EPICRANICI DI SICUREZZA DEHP FREE FLY/SAFE - DEHP FREE SAFETY SCALP VEIN SETS

FLY/SAFE è il set per prelievo ed infusione completo di dispositivo di sicurezza con meccanismo irreversibile. È particolarmente facile da usare e le alette, in codice colore secondo gli Standard Internazionali, garantiscono un'immediata identificazione della misura dell'ago. È atossico ed apirogeno, latex free e sterilizzato ad ossido di etilene. Confezionato in blister singolo.

FLY/SAFE is the sterile safety scalp vein set for taking blood samples and infusions with a safety irreversible mechanism. It is very easy to be used and the colored wings, according to the International Standards, provide an easy identification of the needle size. It is non-toxic and non-pyrogenic, latex free and sterilized by ethylene oxide. Packed in individual blister.

CARATTERISTICHE TECNICHE

- + Ago in acciaio INOX tipo 304 con triplice affilatura.
- + Cappuccio di protezione dell'ago in polipropilene.
- + Meccanismo di sicurezza che ricopre completamente l'ago dopo l'utilizzo, annullando qualunque contatto con lo stesso che, dopo l'uso, si presenta sporco di sangue e dunque potenzialmente infetto.
- + Tubo in PVC o in PVC DEHP free e privo di memoria.
- + Raccordo Luer Lock in PP.
- + Cappuccio del raccordo Luer Lock in polietilene
- + Alette zigrinate in PVC o in PVC DEHP free, in codice colore.
- + Sistema di sicurezza in PP.

TECHNICAL FEATURES

- + Stainless steel needle AISI 304 with triple beveling.
- + Polypropylene needle protection cap.
- + Safety mechanism covering the needle completely, avoiding any contact with it, which is contaminated and dirty of blood after use, so potentially infect.
- + Low memory PVC tube or DEHP free PVC tube
- + PP Luer Lock connector, suitable also for Luer Lock Connector
- + Polyethylene Luer Lock cap.
- + PVC or DEHP free PVC flexible, grained wings, in color code.
- + PP safety mechanism.

Codice Product code	Ago Needle	Colore Colour	Box/Cartone Box/Cartron
S-SVS18GD	18G-1,2x19 mm	●	100/2000 pz/pcs
S-SVS19GD	19G-1,1x19 mm	●	100/2000 pz/pcs
S-SVS20GD	20G-0,9x19 mm	●	100/2000 pz/pcs
S-SVS21GD	21G-0,8x19 mm	●	100/2000 pz/pcs
S-SVS22GD	22G-0,7x19 mm	●	100/2000 pz/pcs
S-SVS23GD	23G-0,6x19 mm	●	100/2000 pz/pcs
S-SVS25GD	25G-0,5x19 mm	●	100/2000 pz/pcs
S-SVS27GD	27G-0,4x19 mm	●	100/2000 pz/pcs

tabella dei GAUGE / GAUGE table

I codici riportati in tabella si riferiscono ai FLY/SAFE con tubo in PVC privo di ftalati.
The codes reported in the table are referred to FLY/SAFE with Phthalates free PVC tube.



CE 0197

Dispositivo Medico classe IIa
Medical Device class IIa



STERILE/EO

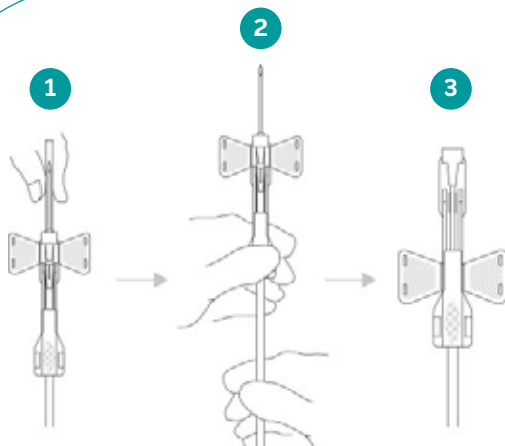

1. Estrarre l'ago dalla confezione sterile, sfilare il copri-ago evitando di toccare l'ago e procedere con l'utilizzo.
2. Al termine della procedura, posizionare i polpastrelli in corrispondenza delle zigrinature e far scorrere in avanti il dispositivo di sicurezza, fino ad avvertire un "click" che rappresenta il blocco irreversibile dell'ago all'interno della protezione.
3. Smaltire come rifiuto ospedaliero.

1. Remove the scalp vein set from the sterile packaging. Remove the needle cap. Avoid any contact with the needle and go on with the use.
2. After the process, put the fingers on the graining and make the safety mechanism slide ahead, until a "click" is heard. It means that the needle has been blocked into the protection irreversibly.
3. Dispose of it properly after use.

ISTRUZIONI D'USO INSTRUCTIONS FOR USE

FLY/SET - AGHI EPICRANICI
FLY/SET - SCALP-VEIN SETS

Gli aghi epicranici FLY/SET sono disponibili in PVC e PVC DEHP free e sono dotati di ago in acciaio Inox con triplice affilatura, per rendere meno traumatico l'inserimento in vena, morbide alette flessibili e zigrinate, in codice colore, per una rapida identificazione della misura dell'ago e tubo con raccordo luer lock.

The scalp vein sets FLY/SET are available in PVC and DEHP free PVC and are provided with stainless steel needle having triple beveling, for a painless vein puncture. They have soft flexible grained wings, in color code, for an easy needle size identification and tube with luer lock terminal.

CONFEZIONI

La linea di aghi epicranici è confezionata in blister e in pratici box che ne consentono un facile prelievo ed una buona conservazione.

PACKAGING

The line of scalp vein sets are packaged in blisters and in practical boxes that will permit an easy pick up and a proper preservation.



Codice Product code	Ago Needle	Colore Colour	Box/Cartone Box/Carton
------------------------	---------------	------------------	---------------------------

PVC

BLISTER SINGOLO / INDIVIDUAL BLISTER PACK

SVS18G	18G - 1,2x19 mm	●	100/2000 pz/pcs
SVS19G	19G - 1,1x19 mm	●	100/2000 pz/pcs
SVS20G	20G - 0,9x19 mm	●	100/2000 pz/pcs
SVS21G	21G - 0,8x19 mm	●	100/2000 pz/pcs
SVS22G	22G - 0,7x19 mm	●	100/2000 pz/pcs
SVS23G	23G - 0,6x19 mm	●	100/2000 pz/pcs
SVS25G	25G - 0,5x19 mm	●	100/2000 pz/pcs
SVS27G	27G - 0,4x19 mm	●	100/2000 pz/pcs

CE 0197

Dispositivo Medico classe IIa
 Medical Device class IIa



STERILE EO

Codice Product code	Ago Needle	Colore Colour	Box/Cartone Box/Carton
------------------------	---------------	------------------	---------------------------

PVC DEHP FREE

BLISTER SINGOLO / INDIVIDUAL BLISTER PACK

SVS18GD	18G - 1,2x19 mm	●	100/2000 pz/pcs
SVS19GD	19G - 1,1x19 mm	●	100/2000 pz/pcs
SVS20GD	20G - 0,9x19 mm	●	100/2000 pz/pcs
SVS21GD	21G - 0,8x19 mm	●	100/2000 pz/pcs
SVS22GD	22G - 0,7x19 mm	●	100/2000 pz/pcs
SVS23GD	23G - 0,6x19 mm	●	100/2000 pz/pcs
SVS25GD	25G - 0,5x19 mm	●	100/2000 pz/pcs
SVS27GD	27G - 0,4x19 mm	●	100/2000 pz/pcs

CE 0197

Dispositivo Medico classe IIa
 Medical Device class IIa



STERILE EO

Hemoflon - Hemocath

AGHI CANNULA STERILI, MONOUSO STERILE, DISPOSABLE IV CATHETER

CARATTERISTICHE TECNICHE

- + Catetere in PUR
- + Punta rastremata
- + Camera di flashback trasparente
- + Dispositivo Medico classe IIa

TECHNICAL FEATURES

- + PUR Catheter
- + Tapered tip
- + Transparent flashback chamber
- + Medical device class IIa



Hemoflon

Codice Product code	Ago Needle	Lunghezza Length	Flusso(ml/min) Flow rate (ml/min)	Colore Colour	Cannula IV Cannula	Box/Cartone Box/Carton
------------------------	---------------	---------------------	--------------------------------------	------------------	-----------------------	---------------------------

A DUE VIE CON ALETTE / WITH WINGS - WITH INJECTION POINT

PHMF16R45	16G	45mm	180	●	PUR	50/500 pz/pcs
PHMF17R45	17G	45mm	125	○	PUR	50/500 pz/pcs
PHMF18R45	18G	45mm	90	●	PUR	50/500 pz/pcs
PHMF18R32	18G	32mm	90	●	PUR	50/500 pz/pcs
PHMF20R32	20G	32mm	60	●	PUR	50/500 pz/pcs
PHMF22R25	22G	25mm	36	●	PUR	50/500 pz/pcs
PHMF24R19	24G	19mm	20	●	PUR	50/500 pz/pcs

CE 1639

Dispositivo Medico classe IIa
Medical Device class IIa



STERILE EO

Hemocath

Codice Product code	Ago Needle	Lunghezza Length	Flusso(ml/min) Flow rate (ml/min)	Colore Colour	Cannula IV Cannula	Box/Cartone Box/Carton
------------------------	---------------	---------------------	--------------------------------------	------------------	-----------------------	---------------------------

AD UNA VIA SENZA ALETTE / WITHOUT WINGS - WITHOUT INJECTION POINT

PHMC16R45	16G	45mm	180	●	PUR	50/500 pz/pcs
PHMC17R45	17G	45mm	125	○	PUR	50/500 pz/pcs
PHMC18R45	18G	45mm	90	●	PUR	50/500 pz/pcs
PHMC18R32	18G	32mm	90	●	PUR	50/500 pz/pcs
PHMC20R32	20G	32mm	60	●	PUR	50/500 pz/pcs
PHMC22R25	22G	25mm	36	●	PUR	50/500 pz/pcs
PHMC24R19	24G	19mm	20	●	PUR	50/500 pz/pcs

CE 1639

Dispositivo Medico classe IIa
Medical Device class IIa



STERILE EO







DISPOSITIVI PER IL DIABETE DEVICES FOR DIABETIC THERAPY

La linea realizzata da Rays S.p.A. per la terapia diabetica comprende una gamma completa, studiata appositamente per poter rispondere al meglio alle esigenze dell'utilizzatore, contribuendo a migliorarne la qualità della vita quotidiana e ad avere il minor impatto possibile su di essa. Comprende, oltre alle siringhe da insulina standard e di sicurezza (pag.52), aghi penna, per la somministrazione dell'insulina, compatibili con tutte le penne da insulina in commercio ed identificati dal codice colore e lancette pungidito standard e di sicurezza, per il prelievo ed autocontrollo glicemico. Entrambi disponibili in una vasta gamma di misure, che permette di scegliere l'ago più adatto alla terapia consigliata dal proprio medico.

The Rays S.p.A. devices for diabetic therapy include a complete range of products, studied for meeting the users' needs, concurring to improve his quality of life and to have the smallest impact on it.

It includes, in addition to the standard and safety insulin syringes (pag.52), insulin pen needles, for the insulin administration, suitable for all the insulin pens available, made in colour code for an easy size identification and standard and safety lancets, for blood sampling and glycaemia self-testing. Both available in a wide range of sizes, allowing to choose the needle size suitable for all kinds of therapies.

AGHI PENNA PER INSULINA STERILI, MONOUSO STERILE, DISPOSABLE INSULIN PEN NEEDLES



Codice Product code	Ago Needle	Colore Colour	Box/Cartone Box/Carton
100-PEN29G12	29Gx12mm	●	100/1200 pz/pcs
100-PEN30G8	30Gx8mm	●	100/1200 pz/pcs
100-PEN31G4	31Gx4mm	●	100/1200 pz/pcs
100-PEN31G5	31Gx5mm	●	100/1200 pz/pcs
100-PEN31G6	31Gx6mm	●	100/1200 pz/pcs
100-PEN31G8	31Gx8mm	●	100/1200 pz/pcs
100-PEN32G4	32Gx4mm	●	100/1200 pz/pcs
100-PEN32G5	32Gx5mm	●	100/1200 pz/pcs
100-PEN32G6	32Gx6mm	●	100/1200 pz/pcs
100-PEN33G4	33Gx4mm	●	100/1200 pz/pcs

CE 0123

Dispositivo Medico classe IIa
Medical Device class IIa



STERILE EO



ISTRUZIONI D'USO / INSTRUCTIONS FOR USE

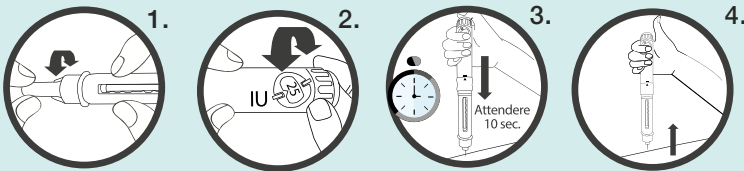

1. Avvitare l'ago sulla penna.
2. Selezionare la dose da iniettare.
3. Effettuare l'iniezione utilizzando la tecnica* consigliata dal medico.
Quando l'ago è inserito, premere il pulsante ed attendere 10 secondi prima di estrarlo.
4. Estrarre l'ago delicatamente e smaltire secondo le normative vigenti.

1. Mount the insulin pen needle on the insulin pen.
2. Select the dosage to inject.
3. Go on with the injection using the technique* recommended by your doctor.
Once it is inserted, press the injection button down and wait for 10 seconds before removing it.
4. After the injection, remove the needle from the pen and dispose of it properly.

LA CORRETTA TECNICA DI INIEZIONE

È importante effettuare l'iniezione dell'insulina utilizzando la giusta tecnica.

LA TECNICA DEL PIZZICO O PLICA

La somministrazione dell'insulina non va effettuata tramite una iniezione intra muscolare. Una tecnica che può aiutare ad evitare un'iniezione nel muscolo è quella del pizzico.

1. Selezionare il sito di iniezione come consigliato e pizzicare la pelle con pollice, indice e medio.
2. È importante sollevare solo la pelle e non il muscolo sottostante.
3. Mantenere la plica sul sito di iniezione durante tutta la somministrazione. Rimuovere lentamente l'ago, rilasciando allo stesso tempo la presa.

THE PROPER INJECTION TECHNIQUE

It is important to use the correct technique during the injection.

THE PINCH-UP TECHNIQUE

Insulin injections should enter the fat just underneath the skin and should avoid the muscle. A technique which can help to avoid the muscle is the pinch-up technique.

1. Select the injection site as recommended by the doctor and pinch the skin up with thumb, index and middle finger.
2. It is important to pinch only the skin and not the muscle under it.
3. Pinch the skin up over the injection site during all the injection, then remove the needle gently leaving the skin.

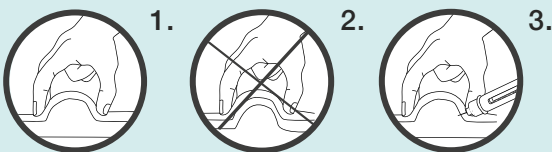

DOVE EFFETTUARE L'INIEZIONE

THE INJECTION SITES

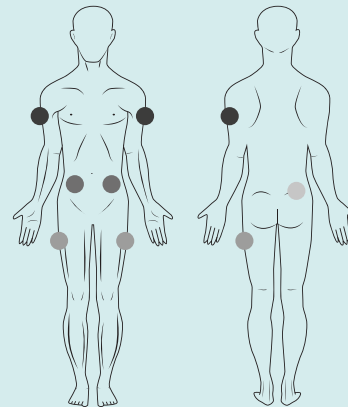

Nella maggior parte dei casi l'insulina viene auto-somministrata, si consiglia pertanto di effettuare l'iniezione nei seguenti 4 siti: addome, cosce, glutei, braccia.

- **ADDOME:** effettuare l'iniezione ad una distanza pari ad un palmo di mano dall'ombelico, evitando di spostarsi lateralmente, dove il sottocute è minore.
 - **COSCE:** solo nella zona anteriore laterale.
 - **GLUTEI:** solo nella zona superiore esterna, evitando di toccare il nervo sciatico.
 - **BRACCIA:** solo nella parte superiore esterna, dove è maggiore il sottocute ed il rischio di toccare il muscolo è minore.
- Si consiglia di numerare i siti di iniezione e di utilizzarli a rotazione, in senso orario.

In most cases there is an insulin self-administration, so it is recommended to do the injection on the following injection sites: abdomen, thighs, the upper buttocks and the back of upper arms.

- **ABDOMEN:** Do the injection at a distance corresponding to a span from the navel, avoiding the side part, where the fat is less.
 - **TIGHTS:** only on the upper sides.
 - **BUTTOCKS:** only on the upper outer area, avoiding the sciatic nerve.
 - **ARMS:** only on the back of the upper area, where there is more fat underneath the skin and the risk to touch the muscle is smaller.
- It is recommended to number the injection sites rotating them in a clockwise direction.



DISPOSITIVI PER TERAPIE INFUSIONALI *INFUSION THERAPY DEVICES*

L'impegno costante profuso nella ricerca in campo medico, consente oggi alla Rays S.p.A. di offrire una gamma completa ed innovativa di dispositivi medici per la terapia infusionale. Le soluzioni proposte sono in grado di soddisfare le diverse esigenze terapeutiche.

Tutti i componenti di elevata qualità, sono stati progettati per garantire un elevato livello di performance nel loro utilizzo congiunto anche con altri dispositivi. I sistemi che ne derivano quindi si distinguono per l'alto livello di modularità, accuratezza e precisione. Tutto ciò garantendo i più elevati standard di sicurezza sia per il paziente che per il personale.

The constant efforts for the research in medical field, today allow Rays S.p.A. to offer a complete and innovative range of medical devices for infusion therapy. The proposed solutions are able to satisfy the different therapeutic needs.

All the high quality components have been designed to ensure a high level performance also by combined usage with other devices. Therefore the derived systems are distinguished by their high capacity of modularity, accuracy and precision. Everything ensures the highest security standards both for the patient and the staff.

SET MONOUSO PER INFUSIONE E TRASFUSIONE DISPOSABLE INFUSION AND TRANSFUSION SET

La gamma dei deflussori e trasfusori **Rays®** è realizzata con materiali di alta qualità, **come il PVC di grado medicale ed il PVC DEHP FREE**, additivi considerati nocivi per la riproduzione. Entrambe le tipologie proposte dalla **Rays S.p.A.** sono in grado rispondere efficacemente alle diverse esigenze terapeutiche che si riscontrano in tutti gli ambiti della medicina per la somministrazione effettuata per gravità. Tutti i componenti sono combinati efficacemente tra loro in una vasta gamma di soluzioni pensate per facilitare il lavoro dell'operatore sanitario e garantire una totale sicurezza nella somministrazione della terapia.

The Rays® range of infusion and transfusion sets is made by high quality medical grade PVC and DEHP free PVC, additives are considered harmful for reproduction. Both types proposed by Rays S.p.A. are able to respond effectively to various therapeutic needs that are found in all areas of medicine for administration effected by gravity. All components are effectively combined together. The wide range of solutions are designed to facilitate the work of health professionals and to guarantee the total security during the administration of therapy.

CARATTERISTICHE TECNICHE

- + Spike in ABS con presa d'aria con filtro da 0,45 micron e tappo in PE
- + Camera in PVC DEHP FREE o PVC, da 4 cm o da 6 cm con filtro soluzione da 15 micron
- + Munito di presa d'aria
- + Punto infusione Latex Free
- + Tubo da 150 fino a 200 mm, in PVC o PVC DEHP FREE
- + Roller in ABS
- + Terminale in ABS con tappo in PE
- + Dispositivo Medico classe IIa

TECHNICAL FEATURES

- + ABS spike with air vent in PVC with 0.45 micron filter and polyethylene cap
- + 4 or 6 cm of chamber in DEHP Free PVC or in PVC, with 15 micron filter solution
- + With PVC
- + Latex free injection point
- + The tube from 150 to 200 mm, in PVC or in DEHP FREE PVC
- + ABS Roller
- + ABS terminal with PE cap
- + Medical device class IIa

SET PER TERAPIE INFUSIONALI CON PUNTO DI INFUSIONE A BARILOTTO SETS FOR INFUSIONAL THERAPIES WITH HOSE INJECTION SITE



Codice Product code	Tubo Tube	Camera Chamber	Punto infusione Injection site	Roller Roller	Terminale Connector	Confezione Unit Packaging unit	Busta/Cartone Bag/Carton
DEF2BL	PVC-150 cm	6 cm	Barilotto / Hose	Standard	Luer	Polybag	25/500 pz/pcs
DEF2BLL	PVC-150 cm	6 cm	Barilotto / Hose	Standard	Luer Lock	Polybag	25/500 pz/pcs
DEF2BLLB	PVC-150 cm	6 cm	Barilotto / Hose	Standard	Luer Lock	Blister	20/360 pz/pcs
DEF2BLLBD	PVC DEHP FREE-150 cm	6 cm	Barilotto / Hose	Standard	Luer Lock	Blister	20/360 pz/pcs
DEF4BLL	PVC-150 cm	4 cm	Barilotto / Hose	Standard	Luer Lock	Polybag	25/500 pz/pcs
DEF4BLLD	PVC DEHP FREE-150 cm	4 cm	Barilotto / Hose	Standard	Luer Lock	Polybag	25/500 pz/pcs

SET PER TERAPIE INFUSIONALI CON PUNTO DI INFUSIONE A "Y" SETS FOR INFUSIONAL THERAPIES WITH "Y" INJECTION SITE



Codice Product code	Tubo Tube	Camera Chamber	Punto infusione Injection site	Roller Roller	Terminale Connector	Confezione Unit Packaging unit	Busta/Cartone Bag/Carton
DEF2YLL	PVC-150 cm	6 cm	Y	Standard	Luer Lock	Polybag	25/500 pz/pcs
DEF2YLLB	PVC-150 cm	6 cm	Y	Standard	Luer Lock	Blister	20/360 pz/pcs
DEF2YLLBD	PVC DEHP FREE-150 cm	6 cm	Y	Standard	Luer Lock	Blister	20/360 pz/pcs
DEF4YLLD	PVC DEHP FREE-150 cm	4 cm	Y	Standard	Luer Lock	Polybag	25/500 pz/pcs
DEF4YLL2D	PVC DEHP FREE-150 cm	4 cm	Y	Standard	Luer Lock	Polybag	25/500 pz/pcs

CE 0197

Dispositivo Medico classe IIa
Medical Device class IIa



STERILE|EO

SET PER TERAPIE INFUSIONALI SENZA PUNTO DI INFUSIONE CON TERMINALE LUER LOCK GIREVOLE SETS FOR INFUSIONAL THERAPIES WITHOUT INJECTION SITE WITH REVOLVING LUER LOCK CONNECTOR

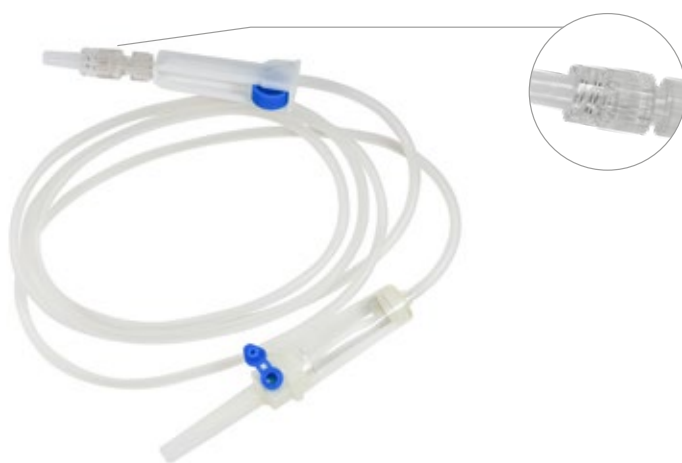

Terminale luer lock girevole
Turning luer lock connector

Codice Product code	Tubo Tube	Camera Chamber	Punto infusione Injection site	Roller Roller	Terminale Connector	Confezione Unit Packaging unit	Busta/Cartone Bag/Carton
DEF4LLGBD	PVC DEHP FREE-150cm	4 cm	NO	Standard	Luer Lock girevole Revolving Luer Lock	Blister	20/360 pz/pcs

CE 0197

Dispositivo Medico classe IIa
Medical Device class IIa



STERILE|EO

SET PER TERAPIE INFUSIONALI SENZA PUNTO DI INFUSIONE CON MICROGOCCIOLATORE E TERMINALE LUER LOCK GIREVOLE
SETS FOR INFUSIONAL THERAPIES WITHOUT INJECTION SITE WITH MICRODIPPER AND REVOLVING LUER LOCK CONNECTOR



Microgocciolatore
Microdipper

Codice Product code	Tubo Tube	Camera Chamber	Punto infusione Injection site	Roller Roller	Terminale Connector	Confezione Unit Packaging unit	Busta/Cartone Bag/Carton
DEM4LLGBD	PVC DEHP FREE-150cm	4 cm	NO	Standard	Luer Lock girevole Revolving Luer Lock	Blister	20/360 pz/pcs

CE 0197

Dispositivo Medico classe IIa
Medical Device class IIa



STERILE EO

DEFLUSSORI NEEDLE FREE
NEEDLE FREE INFUSION SETS



Deflussori di sicurezza con punto d'infusione needle free per la connessione di siringhe senza ago che scongiurano le punture accidentali. Lesioni dovute a punture con ago sono molto frequenti per gli addetti ai lavori nel settore sanitario: l'utilizzo di tale dispositivo, senza richiedere l'uso di alcun ago, permette una connessione più sicura riducendo sensibilmente il rischio di infortuni da puntura d'ago.

Safety infusion sets with needle free system for connecting syringes without needle in order to avoid accidental pricks. Injuries caused by needle pricks are very frequent for the medical staff: the usage of this device, without needle, allows a safer connection reducing the risk of accidents caused by needlestick injury.

Codice Product code	Tubo Tube	Camera Chamber	Pres a d'aria Air vent	Punto infusione Injection site	Roller Roller	Terminale Connector	Confezione Unit Packaging unit	Busta/Cartone Bag/Carton
DEF2NLLD	DEHP FREE 150cm	6 cm	Standard	Needle free	Standard	Luer Lock	Polybag	25/500 pz/pcs

CE 0197

Dispositivo Medico classe IIa
Medical Device class IIa



STERILE EO

REGOLATORI DI FLUSSO HIGH PRECISION FLOW REGULATOR

Regolatore di flusso a tamburo per la somministrazione di soluzioni, in ABS bianco e silicone, con stampata in verde doppia scala graduata da 5 a 250ml/h:

- a) Prima scala (da 5 a 250 ml/h), con numeri verdi su sfondo bianco, utilizzata per soluzioni di grado di viscosità minore o uguale al 10%
- b) Seconda scala (da 5 a 200 ml/h), con numeri bianchi su sfondo verde, deve essere utilizzata per soluzioni con grado di viscosità 10-40%
- Tubo in PVC DEHP FREE lungo 50 cm
- Corpo con all'estremità, da un lato, una corona di semi-cilindri in altorilievo per migliorare la presa durante l'impostazione del flusso, dall'altro, dei rettangoli con lati più corti tondeggianti per rendere la presa più confortevole
- Punto di iniezione a Y latex free (isoprene)
- Terminale luer lock maschio in ABS con cappuccio di protezione in PE
- Terminale luer lock femmina in PVC o PVC DEHP FREE con cappuccio di protezione in PE
- Conforme alla direttiva CEE 93/42
- Dispositivo Medico classe IIa

Flow regulator for solution administrations in white silicon ABS and silicon, with printed green double graduated scale from 5 to 250ml/h:

- a) The first scale (from 5 to 250ml/h) with green numbers on a white background used for viscosity grade solutions minor or equal to 10%
- b) The second scale (from 5 to 200ml/h) with white numbers on green background, should be used for viscosity grade solutions from 10 to 40%

- 50 cm DEHP FREE PVC tube
- Body with, on one side a semi cylinders crown in relief for improving the grip during the rotation for the flow regulation, on the other side, rectangles with the two short sides rounded, for a more comfortable hold
- Latex free Y injection point (isoprene)
- ABS male luer lock terminal with protection cap in PE
- PVC or DEHP FREE PVC female luer lock terminal with protection cap in PE
- In compliance with Directive EEC 93/42
- Medical Device class IIa



CE 0197

Dispositivo Medico classe IIa
Medical Device class IIa



STERILE EO

Codice Product code	Tubo Tube	Punto infusione Injection site	Terminale Connector	Confezione Unit Packaging unit	Busta/Cartone Bag/Carton
RFTE20D	PVC DEHP FREE-30cm	Y	Luer Lock	Blister	25/500 pz/pcs

SET PER TERAPIE INFUSIONALI CON REGOLATORE DI FLUSSO AD ALTA PRECISIONE SETS FOR INFUSIONAL THERAPIES WITH HIGH PRECISION FLOW REGULATOR

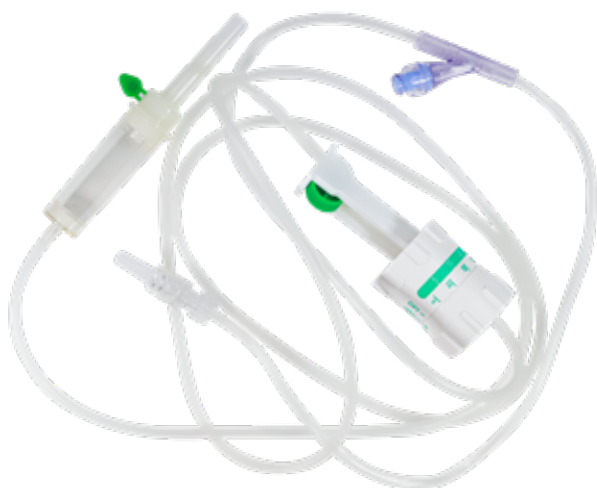

CE 0197

Dispositivo Medico classe IIa
Medical Device class IIa



STERILE EO

Codice Product code	Tubo Tube	Camera Chamber	Punto infusione Injection site	Roller Roller	Terminale Connector	Confezione Unit Packaging unit	Busta/Cartone Bag/Carton
DEF4RLLBD	PVC DEHP FREE-150 cm	4 cm	NO	ad Alta precisione High precision	Luer Lock Luer Lock	Blister	20/100 pz/pcs
DEF4YRLLBD	PVC DEHP FREE-150 cm	4 cm	Y	ad Alta precisione High precision	Luer Lock Luer Lock	Blister	20/100 pz/pcs
DEF4NRLG8BD	PVC DEHP FREE-180cm	4 cm	NEEDLE FREE	ad Alta precisione High precision	Luer Lock girevole Revolving Luer Lock	Blister	20/360 pz/pcs

SET PER TERAPIE INFUSIONALI DI SOSTANZE FOTOSENSIBILI SETS FOR INFUSIONAL THERAPIES OF LIGHT SENSITIVE SUBSTANCES



Codice Product code	Tubo Tube	Camera Chamber	Punto infusione Injection site	Roller Roller	Terminale Connector	Confezione Unit Packaging unit	Busta/Cartone Bag/Carton
DEF4LLGBFP	PVC ambrato -150cm Amber PVC -150cm	6 cm	Senza punto d'infusione Without infusion point	Standard	Luer Lock girevole Revolving Luer Lock	Blister	20/360 pz/pcs

CE 0197 Dispositivo Medico classe IIa
Medical Device class IIa



STERILE EO

SET MONOUSO PER TRASFUSIONI DISPOSABLE SETS FOR TRANSFUSION

Trasfusione per la somministrazione di sangue ed emoderivati.

Transfusion set for blood and blood derivatives administrations.



CARATTERISTICHE TECNICHE

- + Spike in ABS
- + Camera in PVC o PVC DEHP FREE da 9 cm con filtro in nylon da 200 micron
- + Punto infusione LATEX FREE dove previsto
- + Roller in ABS
- + Terminale in ABS con tappo in PE
- + Tubo da 150 cm in PVC o PVC DEHP FREE
- + Dispositivo Medico classe IIa

TECHNICAL FEATURES

- + ABS spike
- + 9 cm Chamber in PVC or DEHP FREE PVC with 200 micron nylon filter
- + Latex free injection point where expected
- + ABS Roller
- + ABS terminal with PE cap
- + 150cm of tube in PVC or DEHP FREE PVC
- + Medical Device class IIa

Codice Product code	Tubo Tube	Punto infusione Injection site	Roller Roller	Terminale Connector	Confezione Unit Packaging unit	Busta/Cartone Bag/Carton
TRASFYLL	PVC - 150 cm	Y	Standard	Luer Lock	Polybag	25/350 pz/pcs
TRASFYLLB	PVC - 150 cm	Y	Standard	Luer Lock	Blister	20/100 pz/pcs
TRASFLL	PVC DEHP FREE-150 cm	-	Standard	Luer Lock	Polybag	25/350 pz/pcs

CE 0197 Dispositivo Medico classe IIa
Medical Device class IIa



STERILE EO

RUBINETTI A TRE VIE LIPIDO RESISTENTI SENZA PROLUNGA LIPID RESISTANT THREE WAY STOPCOCKS WITHOUT EXTENSION TUBE

Raccordo di linee infusionali per la somministrazione di farmaci e soluzioni.

Infusion lines connector for the administration of drugs and solutions.

CARATTERISTICHE TECNICHE

- + Corpo del rubinetto a 3 vie in policarbonato trasparente con raccordi luer lock femmina
- + Cappucci in ABS di colore blu
- + Deviatore in ABS di colore blu
- + Cappuccio luer lock maschio in PE trasparente
- + Rubinetto con rotazione a 360°
- + Stampa di frecce indicatrici della direzione del flusso sul deviatore
- + Dispositivo Medico classe IIa

TECHNICAL FEATURES

- + 3-ways stopcock fully in transparent polycarbonate with female luer lock connectors
- + ABS Caps in blue colour
- + ABS flow deviator in blue colour
- + Male luer lock cap in transparent PE
- + Stopcock with 360° rotation
- + Printed arrows indicate the direction of flow on the deviator
- + Medical Device class IIa



Codice Product code	Prolunga Extension tube	Confezione Unit Packaging unit	Busta/Cartone Bag/Carton
------------------------	----------------------------	-----------------------------------	-----------------------------

CONNETTORE LUER LOCK MASCHIO CON GHIERA GIREVOLE IN ABS TRASPARENTE MALE TRANSPARENT, ROTATING, LUER LOCK CONNECTOR

3W	-	Blister	25/500 pz/pcs
----	---	---------	---------------

CE 0197 Dispositivo Medico classe IIa Medical Device class IIa

RUBINETTI A TRE VIE LIPIDO RESISTENTI CON PROLUNGA LIPID RESISTANT THREE WAY STOPCOCKS WITH EXTENTION TUBE

CARATTERISTICHE TECNICHE

- + Tubo in PVC o PVC DEHP FREE morbido trasparente, privo di memoria
- + Tappino luer lock maschio in PE

TECHNICAL FEATURES

- + Soft, transparent, low memory PVC or DEHP FREE PVC tube
- + Transparent luer lock male cap in PE



Codice Product code	Prolunga Extension tube	Confezione Unit Packaging unit	Busta/Cartone Bag/Carton
------------------------	----------------------------	-----------------------------------	-----------------------------

PVC

3W-10	10 cm PVC	Blister	25/500 pz/pcs
3W-25	25 cm PVC	Blister	25/500 pz/pcs
3W-50	50 cm PVC	Blister	25/500 pz/pcs
3W-80	80 cm PVC	Blister	25/500 pz/pcs

CE 0197 Dispositivo Medico classe IIa Medical Device class IIa

Codice Product code	Prolunga Extension tube	Confezione Unit Packaging unit	Busta/Cartone Bag/Carton
------------------------	----------------------------	-----------------------------------	-----------------------------

PVC DEHP FREE

3W-10D	10 cm PVC DEHP FREE	Blister	25/500 pz/pcs
3W-25D	25 cm PVC DEHP FREE	Blister	25/500 pz/pcs
3W-50D	50 cm PVC DEHP FREE	Blister	25/500 pz/pcs
3W-80D	80 cm PVC DEHP FREE	Blister	25/500 pz/pcs
3W-100D	100 cm PVC DEHP FREE	Blister	25/500 pz/pcs

CE 0197 Dispositivo Medico classe IIa Medical Device class IIa

TAPPINO COMBI STOPPER COMBI STOPPER CAP

Tappino combi stopper in ABS, con luer lock maschio e femmina.

Combi stopper cap in ABS, with male and female luer lock.

CARATTERISTICHE TECNICHE

Dispositivi Medici Classe IIa

TECHNICAL FEATURES

Medical Device Class IIa

Codice Product code	Colore Colour	Busta/Cartone Bag/Carton
CSR	Rosso/Red	100/5000 pz/pcs



CE 0197

Dispositivo Medico classe IIa
Medical Device class IIa



STERILE EO

INJECTION STOPPER INJECTION STOPPER

Tappo connettore in ABS, dotato di membrana latex free utilizzato anche per l'iniezione di eparina - colore giallo

ABS connector cap, equipped with latex free membrane also used for the Heparin injection - yellow color

CARATTERISTICHE TECNICHE

Dispositivi Medici Classe IIa

TECHNICAL FEATURES

Medical Device Class IIa

Codice Product code	Colore Colour	Busta/Cartone Bag/Carton
IS	Giallo/Yellow	25/5000 pz/pcs



CE 0197

Dispositivo Medico classe IIa
Medical Device class IIa



STERILE EO



SACCHE RACCOLTA LIQUIDI FLUID COLLECTION BAG

Le sacche per urina Rays® sono offerte nella versione da adulto. Hanno una capacità di 2000 ml e sono disponibili con tubi di raccordo di diverse misure. Possono essere acquistate nella versione con o senza rubinetto. Tutte sono dotate di valvola antireflusso.

The urine bags Rays® are offered in adult version. They have the capacity of 2000 ml and are available with connecting tubes of various sizes. They can be purchased with or without discharge outlet version. All of them are equipped with non-return valve.



SACCA PER URINA DA LETTO CON SCALA GRADUATA

Sacca per urina da letto con capacità di 2000 ml e scala graduata da 100 ml.

URINE BAG WITH GRADUATED SCALE

Urine bag for bed with capacity of 2000 ml and with graduated scale of 100 ml.

CARATTERISTICHE TECNICHE

- + Sacca in PVC
- + Tubo in PVC
- + Valvola antireflusso in PVC
- + Rubinetto in PE
- + Confezione da 250 pz. in gruppi da 25 pz
- + Dispositivo Medico classe I

TECHNICAL FEATURES

- + PVC bag
- + PVC tube
- + With no return valve
- + PE discharge outlet
- + 250 pcs carton, bundled in 25 pcs
- + Medical Device class I



Codice Product code	Capacità Capacity	Tubo Tube	Rubinetto Discharge outlet	Cartone Carton
------------------------	----------------------	--------------	-------------------------------	-------------------

NON STERILE SENZA CLAMP NON STERILE WITHOUT CLAMP

N2000130Z	2000 ml	130 cm	-	250 pz/pcs
N2000130T	2000 ml	130 cm	a T	250 pz/pcs
N2000090Z	2000 ml	90 cm	-	250 pz/pcs
N2000090T	2000 ml	90 cm	a T	250 pz/pcs

NON STERILE CON CLAMP NON STERILE WITH CLAMP

N2000090TC	2000 ml	90 cm	a T	250 pz/pcs
N2000090ZC	2000 ml	90 cm	-	250 pz/pcs
N2000120ZC	2000 ml	120 cm	-	250 pz/pcs
N2000120TC	2000 ml	120 cm	a T	250 pz/pcs

CE Dispositivo Medico classe I
Medical Device class I



TERAPIA THERAPY

INSTA GELO - GHIACCIO ISTANTANEO TNT INSTA GELO - INSTANT ICE - NON-WOVEN

Ghiaccio istantaneo in busta tessuto non tessuto, contenente miscela di Sali azotati e acqua. Elevata capacità di raffreddamento che perdura per circa 30 minuti.

Instant Ice is a non-woven fabric pack containing mixture of nitrogenous salts and water. The pack has high performance cooling properties that last for about 30 minutes.

CARATTERISTICHE TECNICHE

- + Per contusioni e distorsioni
- + Azione immediata
- + Busta in TNT
- + Dispositivo Medico classe IIa

TECHNICAL FEATURES

- + For contusions and distortions
- + Immediate action
- + Non-woven fabric pack
- + Medical Device class IIa

Codice Product code	Dimensioni Size	Confezionamento primario Primary packaging	Cartone Carton
CP1418T	14 x 18 cm	1 busta/ 1 pack	25 pz/pcs

CE 0197



INSTA GELO - GHIACCIO ISTANTANEO - PE INSTA GELO - INSTANT ICE - PE

Ghiaccio istantaneo in busta pe, contenente miscela di sali azotati e acqua. Elevata capacità di raffreddamento che perdura per circa 30 minuti.

Instant ice is a PE fabric pack containing mixture of nitrogenous salts and water. The pack has high performance cooling properties that last for about 30 minutes.

CARATTERISTICHE TECNICHE

- + Per contusioni e distorsioni
- + Azione immediata
- + Busta in PE
- + Dispositivo Medico classe IIa

TECHNICAL FEATURES

- + For contusions and distortions
- + Immediate action
- + PE fabric pack
- + Medical Device class IIa

Codice Product code	Dimensioni Size	Confezionamento primario Primary packaging	Cartone Carton
CP1418P	14 x 18 cm	1 busta/ 1 pack	25 pz/pcs

CE 0197



DIAGNOSTICA DIAGNOSTICS

GEL TRASPARENTE PER APPARECCHIATURE AD ULTRASUONI, LASER ED IPL TRANSPARENT GEL FOR ULTRASOUND, LASER AND IPL MACHINES

Gel conduttore per apparecchiature a mezzo ultrasuoni.

Conductor Gel for ultrasound machines.

CARATTERISTICHE TECNICHE

- + Ottimizza la trasmissione di onde sonore a frequenza ultrasonica
- + A base acquosa
- + Ipoallergenico
- + Idrosolubile
- + A PH neutro
- + Dispositivo Medico classe I

TECHNICAL FEATURES

- + *Optimizes the transfer of ultrasonic sound waves*
- + *Water-based*
- + *Ipoallergenic*
- + *Water soluble*
- + *Neutral PH*
- + *Medical Device class I*



CE Dispositivo Medico classe I
Medical Device class I



Codice Product code	Capacità Capacity	Bag/Cartone Bag/Carlton
GUS5000*	5000 ml	2pz/cartone - 2pcs/carton

*Cartone da 2 sacche morbide, 2 beccucci dosatori, 1 flacone vuoto da 260ml
*Carton of 2 soft bags, 2 dosing spouts, 1 empty 260ml bottle

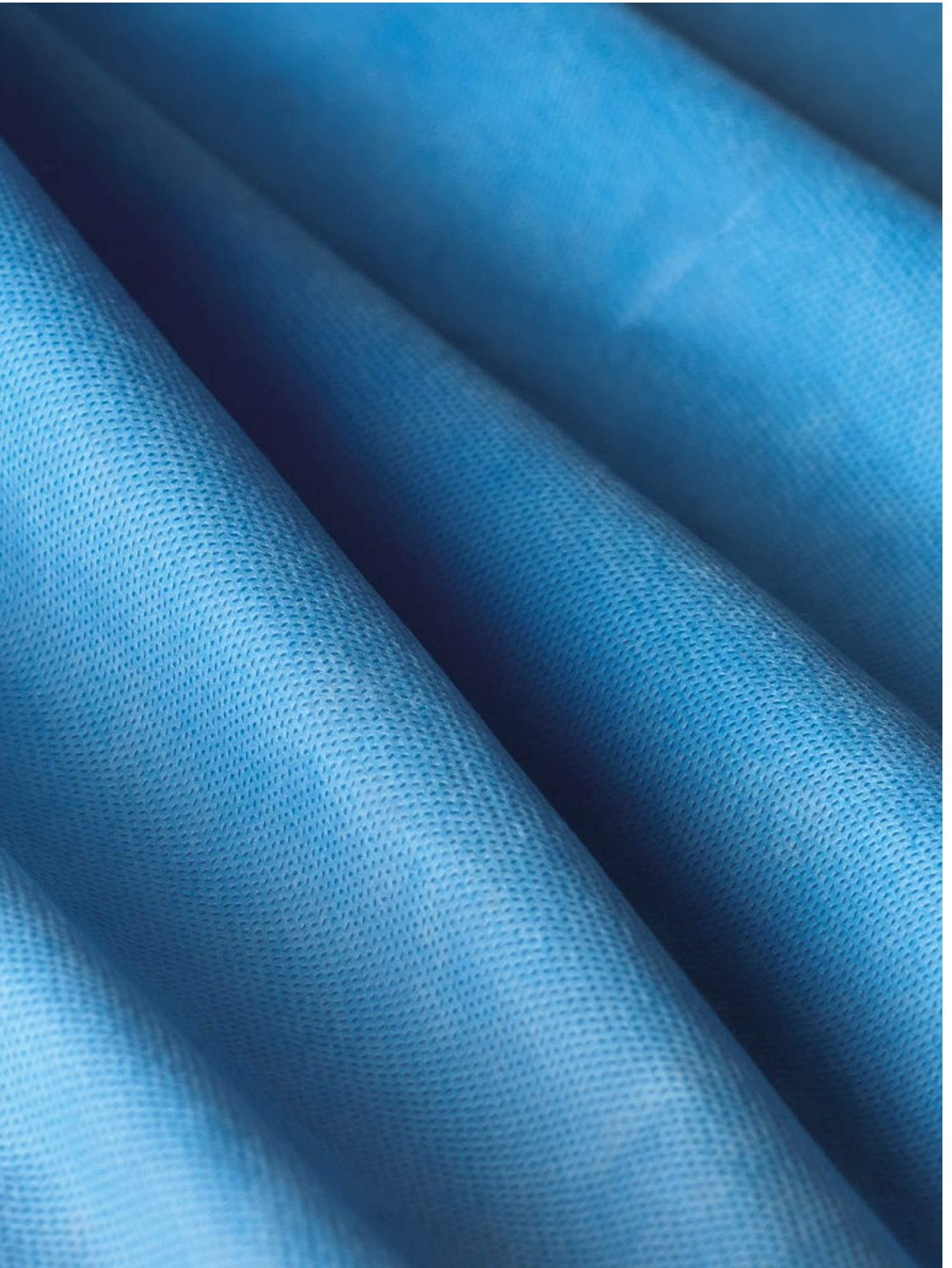

TESSUTO NON TESSUTO, PRODOTTI PER OPERATORI SANITARI NON-WOVEN FABRIC, PRODUCTS FOR HEALTHCARE WORKERS

In sala operatoria, anche in presenza di procedure chirurgiche particolarmente complesse, la protezione deve essere continua e totale, sia per il paziente che per l'equipe operatoria. La gamma dei prodotti realizzati in Tessuto Non Tessuto proposta da Rays S.p.A. garantisce agli operatori un alto grado di sicurezza grazie ad elevati livelli di assorbenza, impermeabilità e idrorepellenza.

Una gamma completa di prodotti destinati al chirurgo, al personale infermieristico ed ai visitatori in grado di offrire soluzioni mirate alle diverse esigenze di protezione, tutti accomunati dall'elevato standard qualitativo.

Protection must be complete and continuous during complicated surgical procedures, both for the patient and for the operating team, inside the surgery especially.

The range of Rays S.p.A. products, made of non-woven fabrics, assures the highest safety level for the medical staff, thanks to high absorbency, impermeability and water repellency qualities.

A wide range of products designed for surgeons, nurses and visitors, able to provide the most specific solution for every level of protection's requirements, always ensuring the highest quality level.

LEGENDA DEI MATERIALI

PE: Polietilene

PP: Polipropilene

SMS: Spunbond / Meltblown / Spunbond

SMMS: Spunbond / Meltblown / Meltblown / Spunbond

TNT: Tessuto non tessuto

LEGEND OF MATERIALS

PE: Polyethylene

PP: Polypropylene

SMS: Spunbond / Meltblown / Spunbond

SMMS: Spunbond / Meltblown / Meltblown / Spunbond

TNT: Non woven fabric

PRODOTTI IN TNT PER LA PROTEZIONE E L'IGIENE DELLA PERSONA

TNT PRODUCTS FOR PERSONAL PROTECTION AND HYGIENE

CLEANCLOTH

Pannetti deterzione mopnuso



CLEANCLOTH

Single-use cleansing cloths

Il panno deterzione monouso **CleanCloth** è un morbido panno, in viscosa e poliestere, utile per la deterzione di viso e corpo. Può essere utilizzato sia da asciutto che da bagnato, rimanendo delicato anche sulle pelli più sensibili.

CleanCloth è altamente assorbente, con elevata resistenza sia da asciutto che da bagnato.

La confezione del panno deterzione monouso **CleanCloth** facilita l'erogazione del prodotto così da garantire il minimo rischio di infezioni incrociate.

*The **CleanCloth** disposable cleansing cloth is a soft cloth, made of viscose and polyester, useful for cleansing the face and body. It can be used both dry and wet, remaining delicate even on the most sensitive skin.*

***CleanCloth** is highly absorbent, with high strength both dry and wet.*

*The packaging of the **CleanCloth** disposable cleansing cloth facilitates the dispensing of the product so as to guarantee the minimum risk of cross-infections.*

Codice Product code	Pz/confezione Pcs/box	N. confezioni N. box	Pz/cartone Pcs/carton	Colore Colour
DRPAN50	50	28	1400	○

MANOPOLA

Manopole saponate e non saponate



WASHCLOTH

Soapy and non-soapy washcloth

E' sufficiente inumidire con acqua la superficie palmare della **manopola monouso** dove è situato il sapone e massaggiare la parte del corpo da trattare. Per un lavaggio totale iniziare dalla testa, proseguire con il dorso, torace, gambe, parti intime, prima i genitali e poi la parte anale e per ultimo i piedi. Una soluzione pratica, igienica, veloce. Soffice ed assorbente, delicata con la pelle aiuta a prevenire le irritazioni causate dalla incontinenza e garantisce massimo comfort al paziente. Il prodotto è esente da lattice.

*Simply moisten the palm surface of the **disposable mitten** where the soap is located with water and massage the part of the body to be treated. For a total wash, start from the head, continue with the back, chest, legs, private parts, first the genitals and then the anal part and lastly the feet. A practical, hygienic, fast solution. Soft and absorbent, gentle on the skin, it helps prevent irritation caused by incontinence and guarantees maximum comfort for the patient. The product is latex-free.*

Codice Product code	Pz/box Pcs/box	Pz/cartone Pcs/carton	Colore Colour
MONO-MNS	20	50	○
MONO-MS	20	50	○
MONO-MSP	20	50	○

BAVAGLIO

Bavaglio monouso con tasca.

DENTAL BIB*Disposable bib with pocket.*

Codice Product code	Descrizione Description	Composizione Composition	Categoria Category	Colore Colour	Taglie Size	Cartone Carton
A213770	37x70 + 10 cm con tasca 37x70 + 10 cm with pocket	PE + CELLULOSE	DM classe I MD Class I	●	Unica	100/900 pz/pcs

**TRAVERSA**

Traversa letto rimboccabile

BED CROSSPIECE*Roll-up bed crossbar*

La **Traversa Letto Rimboccabile** ha comode ali laterali per un fissaggio sicuro in poche semplici mosse. Stendila su letti, divani, poltrone o sui sedili dell'auto, oppure usala per lavare persone allettate: grazie al TNT anallergico in superficie il contatto diretto con la pelle non darà alcun problema di allergia.

*The **Fold-Up Bed Crosspiece** has convenient side wings for secure attachment in a few simple steps. Spread it out on beds, sofas, armchairs or car seats, or use it to wash bedridden people: thanks to the hypoallergenic TNT on the surface, direct contact with the skin will not cause any allergy problems.*

Codice Product code	Dimensione Dimension	Pz/box Pcs/box	Pz/cartone Pcs/carton	Colore Colour
TRAV80180	80x180cm	20	6	○
TRAV4060	40x60cm	20	6	○
TRAV6090	60x90cm	20	6	○
TRAV6060	60x60cm	20	6	○

CAMICI CHIRURGICI SURGICAL GOWNS

La Rays S.p.A. produce ed offre una linea completa di prodotti per rispondere a tutte le necessità della sala operatoria all'avanguardia. Tra questi l'esclusivo camice chirurgico sterile **SURGIGUARD 75, realizzato in un materiale innovativo SMMS, composto da quattro strati di filamenti in polipropilene**. L'SMMS è molto leggero ed assicura altissimi valori di resistenza alla penetrazione di liquidi, alla penetrazione microbica ed alla trazione, in conformità alla normativa EN 13795. Il camice chirurgico sterile **SURGIGUARD 75 è totalmente privo di cuciture grazie alla tecnica della termosaldatura ad ultrasuoni**. Questa novità **garantisce maggiore barriera e sicurezza**. Infatti per effettuare una cucitura è necessario praticare dei fori all'interno dei quali far scorrere il filo e in queste piccole aperture liquidi e batteri possono penetrare senza eccessive difficoltà. Con la termosaldatura i lembi da unire vengono sovrapposti e saldati attraverso il riscaldamento ad ultrasuoni, quindi non ci sono fori o strappi ed anche questo rischio potenziale viene evitato.

*Rays S.p.A. manufactures and offers a full range of products to satisfy all needs of cutting-edge operating rooms. Among the others the exclusive sterile surgical gown **SURGIGUARD 75, made of an innovative SMMS material, composed of four layers of polypropylene filaments**. SMMS material is very light and ensures high resistance against liquids and bacteria penetration and tensile strength, in compliance with EN 13795 standards. The sterile surgical gown **SURGIGUARD 75 is completely seamless, thanks to the ultrasonic thermal sealing technique**.*

*This innovation **assures stronger barrier and higher security**. As a matter of fact to stitch a fabric it is necessary to pierce the fabric in order to let the yarn pass through: these micro holes can be easily penetrated by liquids and bacteria. Thanks to the thermal sealing the edges are overlapped and sealed through the ultrasonic heating, therefore there is no perforation nor tears so that even this potential risk is avoided.*





Rinforzo interno in PE in grado di garantire la massima protezione da eventuali contaminazioni di sangue ed emoderivati
PE internal reinforced parts to grant the maximum protection against possible blood and blood derivatives contaminations

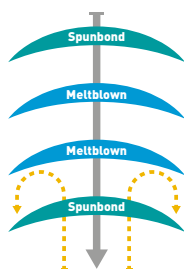

4 strati che compongono SMMS
4 layers that compose SMMS

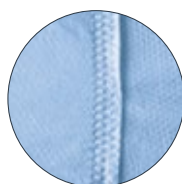

Tessuto termosaldato
Thermo sealed fabric



Confezione con apertura peel-open e doppia etichetta adesiva per la rintracciabilità
Peel-open pouch with double adhesive label for traceability

CARATTERISTICHE TECNICHE

- + Idrorepellente
- + Cuciture termosaldate a ultrasuoni
- + Chiusura totale posteriore con sovrapposizione dei lembi e 4 fettucce
- + Chiusura al collo regolabile con velcro
- + Ottima traspirabilità
- + Rilascio di particelle nullo
- + Presenza nella confezione di 2 tovagliette asciugamani
- + Conforme alla UNI EN 13795
- + Dispositivo Medico classe I s

TECHNICAL FEATURES

- + Water repellent
- + Ultrasonic thermo-sealed seams
- + Total back closure with overlapping edges and 4 strings
- + Adjustable velcro closure on neck
- + Excellent breathability
- + No particle release
- + Package provided with 2 hand towels
- + In compliance with UNI EN 13795
- + Medical Device class I s

Codice Product code	Descrizione Description	Colore Colour	Taglie Size	Busta/cartone Polybag/carton
S404753-S	Sterile	●	S/M/L/XL/XXL	25 pz/pcs
S404753-S-R	Sterile - Rinforzato <i>Sterile - Reinforced</i>	●	S/M/L/XL/XXL	25 pz/pcs

CE 1370

Dispositivo Medico classe I s
Medical Device class I s



STERILE EO

Verificare sempre la disponibilità.
Always check availability.

CAMICI VISITATORE *ISOLATION GOWNS*

I camici sono realizzati in tessuto non tessuto di polipropilene di ultima generazione. Le eccezionali caratteristiche di resistenza ed impermeabilità, il basso linthing e il bassissimo livello di infiammabilità offrono la massima sicurezza al paziente. Camici protettivi monouso per visitatori e infermieri, utilizzabili anche per la protezione dei pazienti. La linea è composta da camici, casacche e pantaloni totalmente in polipropilene e disponibili in diverse misure per adattarsi ad ogni esigenza.

Gowns are made of non-woven polypropylene fabric of the latest generation. The exceptional resistance and watertight properties, the low linthing and the lowest flammable risk, guarantee the best protection for the patient. Single use protective gowns for visitors and nurses, also suitable for the protection of patients. This range is composed of gowns, coats and trousers, made of polypropylene and available in many sizes, in order to meet all users' needs.



CAMICI VISITATORE

Camice visitatore con polsini in maglina o con elastico.

ISOLATION GOWNS



Isolation gown with knitted cuffs or elastic cuffs.

CARATTERISTICHE TECNICHE

- + Senza colletto
- + Chiusura posteriore con lacci al collo e alla vita
- + Ottima traspirabilità
- + Dispositivo Medico classe I

TECHNICAL FEATURES

- + No collar
- + Back fastening with laces at neck and waist
- + Excellent breathability
- + Medical Device class I

Codice Product code	Descrizione Description	Composizione Composition	Colore Colour	Taglie Size	Busta/cartone Polybag/carton
401283V	Polsini in maglina / Knitted cuffs	PP		S/M/L/XL	10/100 pz/pcs
401283ECV	Polsini con elastico Elastic cuffs	PP		S/M/L/XL	10/100 pz/pcs

CE Dispositivo Medico classe I
Medical Device class I



Polsini con elastico
Elastic cuff



Polsini in maglina
Knitted cuff

TWIN SET

Completo casacca e pantalone.

TWIN SET

Coat and trousers set.

CARATTERISTICHE TECNICHE

- + Casacca senza colletto con manica corta
- + Pantalone con coulisse in vita
- + Ottima traspirabilità
- + Dispositivo Medico classe I

TECHNICAL FEATURES

- + Shirt without collar and with short sleeves
- + Trousers with drawstring at waist
- + Excellent breathability
- + Medical Device class I

Codice Product code	Descrizione Description	Composizione Composition	Colore Colour	Taglie Size	Busta/cartone Polybag/carton
405506A	Completo/Set	PP		S/M/L/XL/XXL	25 pz/pcs

CE Dispositivo Medico classe I
Medical Device class I



405506A

MASCHERINE CHIRURGICHE SURGICAL MASKS

L'ampia gamma di mascherine chirurgiche offerte dalla Rays S.p.A. garantisce la massima protezione per l'operatore e per il paziente.

Sono state studiate e progettate per ridurre l'esposizione dell'utilizzatore agli agenti pericolosi aerodispersi.

La linea HIGH PROTECTION MASK è realizzata per proteggere da particelle microscopiche, polveri sottili, agenti biologici e influenze pandemiche. Garantisce una efficace proprietà di protezione e, nello stesso tempo, un'elevata capacità di adattarsi perfettamente al viso.

The wide range of surgical masks proposed by Rays S.p.A. guarantees the highest protection level both for medical staff and for the patients.

Conceived and designed specifically to reduce the exposure of the user to dangerous airborne agents.

The HIGH PROTECTION MASK line is realized to protect against microscopic particles, particulates, biological agents and pandemic viruses. Assures the most efficient protection and at the same time the best fit.



MASCHERINE CHIRURGICHE

Mascherine chirurgiche con elastici auricolari, lacci dietro la nuca.

SURGICAL MASKS

Surgical masks with elastic ear-loops, nape laces.

CARATTERISTICHE TECNICHE

- + Forma a soffietto
- + Stringinaso in alluminio
- + Strati termosaldati alle estremità
- + In polipropilene
- + Dispositivi Medici Classe I

TECHNICAL FEATURES

- + Folding shaped
- + Aluminium noseclip
- + Thermo-sealed layers at edges
- + Polypropylene
- + Medical Device Class I

3 STRATI / 3 LAYERS

Codice Product code	Descrizione Description	Colore Colour	Busta/cartone Package/carton
208283BB	Elastici auricolari / Elastic ear-loops		50/2000 pz/pcs
208283BV	Elastici auricolari / Elastic ear-loops		50/2000 pz/pcs
208283AV	Lacci dietro la nuca / Nape strings		50/2000 pz/pcs

CE Dispositivo Medico classe I
Medical Device class I



208283BB



208283BV



208283AV

PROTEZIONE PARZIALE DEL CORPO BODY'S PARTIAL PROTECTIONS

I prodotti in tessuto non tessuto della linea LIFEGUARD PROFESSIONAL sono destinati alla protezione parziale del corpo e sono stati concepiti specificatamente per il mercato sanitario. Tutti i prodotti sono certificati e risultano particolarmente indicati in quelle situazioni dove si può verificare un'esposizione, anche potenziale, ad agenti biologici come batteri e virus. Tutti i prodotti risultano particolarmente indicati in quelle situazioni dove si può verificare un'esposizione, anche potenziale, ad agenti biologici come batteri e virus.

LIFEGUARD PROFESSIONAL products for body's partial protection in non-woven fabric are conceived specifically for health care market.

All the products are particularly indicated in all the situations where exposure, even potential, to biological agents such as bacteria and viruses can occur.

We dedicated special attention to the design of the products, in order to ensure the best wearability and therefore more agility.



CAMICI DA LABORATORIO

Camici da laboratorio con colletto, elastico ai polsi, tasche e chiusura con bottoni a pressione o con velcro.

LAB COATS

Lab coats with collar, wrist elastic band, pockets and press studs fastening.



SILICON
FREE

504030W

CAMICI VISITATORE

Camici visitatore con colletto, tasche e chiusura con bottoni a pressione.

LAB COATS

Lab coats with collar, pockets and press studs fastening



504030WW

Codice Product code	Descrizione Description	Composizione Composition	Categoria Category	Colore Colour	Taglie Size	Cartone Carton
504030W	Camice da laboratorio in polipropilene da 50 g/m ² con tasche esterne, colletto e chiusura con bottoni a pressione <i>50 gr/m² polypropylene lab coat with external pockets, collar and press studs fastening</i>	PP	DM classe I <i>MD Class I</i>	○	M/L/XL/ XXL	100 pz/pcs
504030WW	Camice da laboratorio in SMS da 30 g/m ² con tasche interne e chiusura con velcro <i>30 gr/m² lab coat with inner pockets, collar and velcro fastening</i>	SMS	DPI I Cat. <i>PPE I Cat.</i>	○	M/L/XL/ XXL	100 pz/pcs



Verificare sempre la disponibilità.
Always check availability.

GREMBIULI

Grebiule con allacciatura posteriore.

APRONS

Apron with back fastening.



APR20B - APR40B



APR20W - APR40W

Codice Product code	Descrizione Description	Composizione Composition	Categoria Category	Colore Colour	Taglie Size	Busta/cartone Polybag/carton
APR20B	Grebiule - PE 20 micron Apron - PE 20 micron	PE	DPI I Cat. - PPE I Cat.	●	Unica 70x120 cm One size 70x120 cm	100/1000 pz/pcs
APR20W	Grebiule - PE 20 micron Apron - PE 20 micron	PE	DPI I Cat. - PPE I Cat.	○	Unica 70x120 cm One size 70x120 cm	100/1000 pz/pcs
APR40B	Grebiule - PE 40 micron Apron - PE 40 micron	PE	DPI I Cat. - PPE I Cat.	●	Unica 80x140 cm One size 80x140 cm	100/500 pz/pcs
APR40W	Grebiule - PE 40 micron Apron - PE 40 micron	PE	DPI I Cat. - PPE I Cat.	○	Unica 80x140 cm One size 80x140 cm	100/500 pz/pcs



Verificare sempre la disponibilità.
Always check availability.

COPRIMANICHE

Manicotti con bordi elastici - DPI I categoria

SLEEVE COVERS

Sleeve covers with elastic string - PPE I category



SLV20W



SLV20B

Codice Product code	Descrizione Description	Composizione Composition	Colore Colour	Taglie Size	Busta/cartone Polybag/carton
SLV20B	Manicotto in PE 20 micron, bordi con elastico 20 micron PE sleeve cover, with elastic string	PE	●	Unica 40x20 cm One size 40x20 cm	100/2000 pz/ pcs
SLV20W	Manicotto in PE 20 micron, bordi con elastico 20 micron PE sleeve cover, with elastic string	PE	○	Unica 40x20 cm One size 40x20 cm	100/2000 pz/ pcs



COPRICAPI CHIRURGICI

Copricapo chirurgico a forma integrale o a tamburo.
DM classe I

SURGICAL CAPS

Integral shape surgical cap or cylinder shape surgical cap.
MD class I



201283V

Codice Product code	Descrizione Description	Composizione Composition	Colore Colour	Taglie Size	Busta/cartone Package/carton
201283V	Forma a tamburo, lacci dietro la nuca Cylinder shape, nape laces	PP	●	Unica One size	100/1000 pz/pcs



CUFFIE

Cuffia a forma tonda con elastico su tutto il perimetro
Ottima traspirabilità - DM classe I

CAPS

Round shape cap style with elastic string
Excellent breathability - MD class I



209143-21V



209143-21W



201020W

Codice Product code	Descrizione Description	Composizione Composition	Colore Colour	Taglie Size	Busta/cartone Polybag/carton
209143-21V	Forma tonda, con elastico Round shape, elastic string	PP	●	Unica One size	100/1000 pz/ pcs
209143-21W	Forma tonda, con elastico Round shape, elastic string	PP	○	Unica One size	100/1000 pz/ pcs
201020W	Forma a fisarmonica, con elastico Typical accordion shape, elastic string	PP	○	Unica One size	100/1000 pz/ pcs



Verificare sempre la disponibilità.
Always check availability.

COPRISCARPE

Copriscarpa con elastico alla caviglia - DM classe I

SHOE COVERS

Shoe cover with ankle elastic string - MD class I



Codice Product code	Descrizione Description	Composizione Composition	Colore Colour	Taglie Size	Confezione/cartone Package/carton
302403CPE	3,2 g 3,2 gr	PE	●	Unica 40 cm One size 40 cm	100/2000 pz/pcs



Verificare sempre la disponibilità.
Always check availability.

COPRIMATERASSO

Coprimaterasso impermeabile

MATTRESS COVER

Waterproof mattress cover



Coprimaterasso impermeabile morbido e resistente di colore. Facile da posizionare grazie al morbido elastico perimetrale, che avvolge per intero il materasso, misura universale. Di facile posizionamento, si adatta perfettamente a tutti i materassi singoli, ospedalieri e domiciliari, inoltre il sistema con elastico perimetrale, garantisce la copertura totale del materasso. Questo prodotto è indispensabile per garantire la massima igiene, una soluzione ottimale per salvaguardare il materasso, da liquidi. Ideali sia per l'uso professionale, nei reparti ospedalieri, case di riposo, e RSA, ma anche nell'uso privato. Si consiglia la sostituzione ciclica del prodotto, per evitare possibili contaminazioni.

*Soft and durable **waterproof mattress cover** in color. Easy to position thanks to the soft perimeter elastic, which completely wraps the mattress, universal size. Easy to position, it adapts perfectly to all single, hospital and home mattresses, furthermore the system with perimeter elastic guarantees total coverage of the mattress. This product is essential to guarantee maximum hygiene, an optimal solution to protect the mattress from liquids.*

Ideal both for professional use, in hospital departments, retirement homes, and RSAs, but also for private use. We recommend cyclical replacement of the product, to avoid possible contamination.

Codice Product code	Dimensione L x W Dimension L x W	Pz/box Pcs/box	Pz/cartone Pcs/carton	Colore Colour
COPMAT2109020	210x90cm	10	100	●



FACCIALI FILTRANTI FILTERING MASKS

I facciali filtranti LIFEGUARD FILTERING PROTECTIVE MASKS garantiscono una protezione confortevole e affidabile.

Disponibili con o senza valvola, eliminano efficacemente calore e umidità, riducendo il rischio di annebbiamento degli occhiali e allo stesso tempo rendendo più confortevole l'uso del facciale. Disponibili nelle classi FFP1, FFP2 e FFP3, dotati di lembi per adattarsi perfettamente ai movimenti del viso anche in caso di utilizzo con degli occhiali. Tutti i dispositivi sono rispondenti alle normative EN 149:2001 + A1:2009 e successive modifiche.

LIFEGUARD FILTERING PROTECTIVE MASKS filtering masks ensure a comfortable and reliable protection.

They are available with or without valve, eliminate efficiently heat and humidity, reducing the risk of glasses misting and at the same time making the use of the mask more comfortable. Available in FFP1, FFP2 and FFP3 classes, equipped with flaps to adapt perfectly to the movements of the face even when used with glasses.

All devices comply with the standards EN 149: 2001 + A1: 2009 and subsequent amendments.



FACCIALI FILTRANTI PIEGHEVOLI

Facciali filtranti monouso pieghevoli.

FOLDABLE FILTERING MASKS

Disposable foldable filtering face masks.

CARATTERISTICHE TECNICHE

- + Multistrato in polipropilene e cotone
- + Stringinaso interno in alluminio
- + Piegata verticalmente
- + Doppio elastico tipo "ear-loop"
- + Imbustati singolarmente
- + DPI III categoria

TECHNICAL FEATURES

- + Polypropylene and cotton multilayer
- + Aluminium internal noseclip
- + Vertically folded
- + Double nape elastic string "ear-loop" type
- + Single packaging
- + PPE III category

Codice Product code	Descrizione Description	Classe Class	Colore Colour	Box/cartone Box/carton
SAVE 23W FFP2	Forma pieghevole con doppio elastico tipo "ear-loop" <i>Foldable shaped with double nape elastic string "ear-loop" type</i>	FFP2 NR	○	2000 pz/pcs
SAVE 23B FFP2	Forma pieghevole con doppio elastico tipo "ear-loop" <i>Foldable shaped with double nape elastic string "ear-loop" type</i>	FFP2 NR	●	2000 pz/pcs

CE 2797 



SAVE 23W FFP2



SAVE 23 B FFP2

FACCIALI FILTRANTI PIEGHEVOLI

Facciali filtranti monouso pieghevoli, con o senza valvola.

FOLDABLE FILTERING MASKS

Disposable foldable filtering face masks, with or without valve.

CARATTERISTICHE TECNICHE

- + Multistrato in polipropilene
- + Stringinaso interno in alluminio e plastica
- + Adattatore nasale interno
- + Piegata orizzontalmente
- + Doppio elastico regolabile
- + DPI III categoria

TECHNICAL FEATURES

- + Polypropylene multilayer
- + Aluminium and plastic internal noseclip
- + Internal nose adaptor
- + Horizontally folded
- + Adjustable double elastic band
- + PPE III category

Codice Product code	Descrizione Description	Classe Class	Colore Colour	Box/cartone Box/carton
SAVE F FFP1-V	Con valvola, elastico giallo With valve, yellow elastic band	FFP1 NR	○	10/120 pz/pcs
SAVE F FFP2	Senza valvola, elastico blu Without valve, light blue elastic band	FFP2 NR	○	20/240 pz/pcs
SAVE F FFP2-V	Con valvola, elastico blu With valve, light blue elastic band	FFP2 NR	○	10/120 pz/pcs
SAVE F FFP3-V	Con valvola, elastico rosso With valve, red elastic band	FFP3 NR	○	10/120 pz/pcs



Verificare sempre la disponibilità.
Always check availability.



SAVE F FFP1-V



SAVE F FFP2



SAVE F FFP2-V



SAVE F FFP3-V

FACCIALI FILTRANTI A CONCHIGLIA

Facciali filtranti monouso, con o senza valvola, due elastici nucali fissi o doppio elastico regolabile.

SHELL-SHAPED FILTERING MASKS

Disposable filtering face masks, with or without valve, two fixed nape elastic strings or adjustable double elastic band.

CARATTERISTICHE TECNICHE

- + Multistrato in polipropilene
- + Stringinaso in alluminio
- + Adattatore nasale interno
- + DPI III categoria

TECHNICAL FEATURES

- + Polypropylene multilayer
- + Aluminium noseclip
- + Internal nose adaptor
- + PPE III category

Codice Product code	Descrizione Description	Classe Class	Colore Colour	Box/cartone Box/carton
SAVEMASK FFP1	Senza valvola, due elastici fissi nucali gialli. <i>Without valve, two fixed yellow nape elastic bands.</i>	FFP1 NR	○	20/240 pz/pcs
SAVEMASK FFP1/V	Con valvola, due elastici fissi nucali gialli. <i>With valve, two fixed yellow nape elastic bands.</i>	FFP1 NR	○	10/120 pz/pcs
SAVEMASK FFP1D/V	Con valvola, doppio elastico regolabile e quattro punti di ancoraggio, stringinaso in alluminio. Testato con polveri di Dolomite. <i>With valve, adjustable double elastic band and four fixing points, aluminum nose clip. Tested with Dolomite powder.</i>	FFP1 NR D	○	10/120 pz/pcs
SAVEMASK FFP2	Senza valvola, due elastici fissi nucali azzurri. <i>Without valve, two fixed light blue nape elastic bands.</i>	FFP2 NR	○	20/240 pz/pcs
SAVEMASK FFP2/V	Con valvola, due elastici fissi nucali azzurri. <i>With valve, two fixed light blue nape elastic bands.</i>	FFP2 NR	○	10/120 pz/pcs
SAVEMASK FFP2D/V	Con valvola, doppio elastico regolabile e quattro punti di ancoraggio, stringinaso in alluminio. Testato con polveri di Dolomite. <i>With valve, adjustable double elastic band and four fixing points, aluminum nose clip. Tested with Dolomite powder.</i>	FFP2 NR D	○	10/120 pz/pcs
SAVEMASK FFP3/V	Con valvola, doppio elastico regolabile e quattro punti di ancoraggio, guarnizione interna sagomata, stringinaso interno in alluminio e plastica. <i>With valve, adjustable double elastic band and four fixing points, internal soft gasket, aluminium and plastic internal noseclip.</i>	FFP3 NR	○	5/60 pz/pcs
SAVEMASK FFP3D/V	Con valvola, doppio elastico regolabile con quattro punti di ancoraggio, guarnizione interna sagomata, stringinaso interno in alluminio e plastica. Testato con polveri di Dolomite. <i>With valve, adjustable double elastic band, with four fixing points, internal soft gasket, aluminium and plastic internal noseclip. Tested with Dolomite powder.</i>	FFP3 NR D	○	10/120 pz/pcs

CE 2797

 Verificare sempre la disponibilità.
Always check availability.

SAVEMASK FFP1



SAVEMASK FFP1/V



SAVEMASK FFP1D/V

 DOLOMITE
POWDER
TESTED

SAVEMASK FFP2



SAVEMASK FFP2/V



SAVEMASK FFP2D/V

 DOLOMITE
POWDER
TESTED

SAVEMASK FFP3/V



SAVEMASK FFP3D/V

 DOLOMITE
POWDER
TESTED

TUTE PROTETTIVE PROTECTIVE COVERALLS

Le tute protettive LIFEGUARD PROTECTION sono state progettate per la piena mobilità ed un elevato comfort in tutte le condizioni di utilizzo. I materiali utilizzati frutto di una ricerca approfondita riescono a coniugare praticità e resistenza con un elevato livello di protezione dalle aggressioni di agenti chimici. **Tutti i prodotti proposti sono di alta qualità e soddisfano le specifiche richieste delle principali normative europee per i dispositivi di protezione individuale e testate anche per l'utilizzo medico sanitario.** La gamma, tra le più complete presentate sul mercato, offre all'utilizzatore la più ampia scelta di protezione, anche per elaborazioni o manipolazioni in ambienti particolarmente critici.

LIFEGUARD PROTECTION protective coveralls are designed for full dexterity and the highest comfort in every use situation. The choice of materials is the result of an accurate research and can mix practicalness and resistance with the highest protection rate against chemical agent risks. All our products have the best quality level, comply with the specific European standards for individual protection devices and have been tested for medical use. The most complete range on the market offers the users the widest protecting choice, even during elaborating or manipulating processes in significantly critical environments.





Polsini in maglina
Knitted cuffs



Elastico posteriore in vita per un'aderenza superiore al corpo.
Back elastic band at waist, for a major body adherence.



Patta copricerniera dotata di striscia adesiva per garantire un elevato livello di ermeticità contro i liquidi.
Adhesive strip zip cover, to guarantee a high level of waterproofness.



SILICON FREE



Confezione sottovuoto
Vacuum polybag



LIFEGUARD MASTER TUTA PROTETTIVA PROTECTIVE COVERALL

CARATTERISTICHE TECNICHE

- + Cuciture interamente ricoperte e sigillate da nastro di colore azzurro
- + Cappuccio con elastico
- + Polsini in maglina
- + Patta copricerniera dotata di striscia adesiva
- + Elastico posteriore in vita
- + Bordo elastico alle caviglie
- + Giro manica ampio per garantire la massima vestibilità e comfort
- + Rilascio di particelle nullo
- + Assenza di silicone
- + DPI III categoria

TECHNICAL FEATURES

- + Stitching entirely sealed with blue ribbon
- + Hood with elastic border
- + Knitted cuffs
- + Adhesive strip zip cover
- + Back elastic band at waist
- + Elastic band at ankle
- + Wide armhole for a maximum wearability and comfort during usage
- + No particles release
- + Silicon-free
- + PPE III category

Codice Product code	Descrizione Description	Composizione Composition	Colore Colour	Taglie Size	Cartone Carton
101401-MA	Tuta protettiva 63 g/m ² Protective overall 63 gr/m ²	Non tessuto laminato Non woven laminated	○	M/L/XL/XXL/XXXL	50 pz/pcs





Polsini elastici
Elastic cuffs



Elastico posteriore in vita per un'aderenza superiore al corpo.
Back elastic band at waist, for a major body adherence.



Patta copricerniera dotata di striscia adesiva per garantire un elevato livello di ermeticità contro i liquidi.
Adhesive strip zip cover, to guarantee a high level of waterproofness.

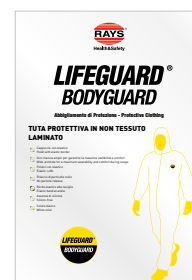

Confezione
Polybag



LIFEGUARD BODYGUARD

TUTA PROTETTIVA PROTECTIVE COVERALL

CARATTERISTICHE TECNICHE

- + Cappuccio con elastico
- + Polsini elastici
- + Patta copricerniera dotata di striscia adesiva
- + Elastico posteriore in vita
- + Bordo elastico alle caviglie
- + Giro manica ampio per garantire la massima vestibilità e comfort
- + Rilascio di particelle nullo
- + Assenza di silicone
- + DPI III categoria

TECHNICAL FEATURES

- + Hood with elastic border
- + Elastic cuffs
- + Adhesive strip zip cover
- + Back elastic band at waist
- + Elastic band at ankle
- + Wide armhole for a maximum wearability and comfort during usage
- + No particles release
- + Silicon-free
- + PPE III category

Codice Product code	Descrizione Description	Composizione Composition	Colore Colour	Taglie Size	Cartone Carton
101401-BG	Tuta protettiva 55 g/m ² Protective overall 55 gr/m ²	Non tessuto laminato Non woven laminated	○	S/M/L/XL/XXL/XXXL	50 pz/pcs





Polsini in maglina
Knitted cuffs



Elastico posteriore in vita per un'aderenza superiore al corpo.
Back elastic band at waist, for a major body adherence.



Patta copricerniera dotata di striscia adesiva per garantire un elevato livello di ermeticità contro i liquidi.
Adhesive strip zip cover, to guarantee a high level of waterproofness.



Confezione sottovuoto
Vacuum polybag



LIFEGUARD PLUS

TUTA PROTETTIVA PROTECTIVE COVERALL

CARATTERISTICHE TECNICHE

- + Cappuccio con elastico
- + Polsini in maglina
- + Patta copricerniera dotata di striscia adesiva
- + Elastico posteriore in vita
- + Bordo elastico alle caviglie
- + Giro manica ampio per garantire la massima vestibilità e comfort
- + Rilascio di particelle nullo
- + Assenza di silicone
- + DPI III categoria

TECHNICAL FEATURES

- + Hood with elastic border
- + Knitted cuffs
- + Adhesive strip zip cover
- + Back elastic band at waist
- + Elastic band at ankle
- + Wide armhole for a maximum wearability and comfort during usage
- + No particles release
- + Silicon-free
- + PPE III category

Codice Product code	Descrizione Description	Composizione Composition	Colore Colour	Taglie Size	Cartone Carton
101401-TLA	Tuta protettiva 63 g/m ² Protective overall 63 gr/m ²	Non tessuto laminato Non woven laminated	○	S/M/L/XL/XXL/XXXL	50 pz/pcs





Polsini in maglina
Knitted cuffs



Elastico posteriore in vita per un'aderenza superiore al corpo.
Back elastic band at waist, for a major body adherence.



Patta copricerniera dotata di striscia adesiva per garantire un elevato livello di ermeticità contro i liquidi.
Adhesive strip zip cover, to guarantee a high level of waterproofness.



Confezione
Polybag



LIFEGUARD PRO®
TUTA PROTETTIVA PROTECTIVE COVERALL

CARATTERISTICHE TECNICHE

- + Tessuto non tessuto ad elevata traspirabilità ed idrorepellente
- + Cappuccio con elastico
- + Polsini in maglina
- + Patta copricerniera dotata di striscia adesiva
- + Elastico posteriore in vita
- + Bordo elastico alle caviglie
- + Giro manica ampio per garantire la massima vestibilità e comfort
- + Assenza di silicone
- + DPI III categoria

TECHNICAL FEATURES

- + Special non-woven fabric with high breathability and waterproof
- + Hood with elastic border
- + Knitted cuffs
- + Adhesive strip zip cover
- + Back elastic band at waist
- + Elastic band at ankle
- + Wide armhole for a maximum wearability and comfort during usage
- + Silicon-free
- + PPE III category

Codice Product code	Descrizione Description	Composizione Composition	Colore Colour	Taglie Size	Cartone Carton
101401W-SA	Tuta protettiva 50 g/m ² Protective coverall 50 gr/m ²	SMS	○	M/L/XL/XXL/XXXL	50 pz/pcs





Confezione
Polybag



Confezione
Polybag

LIFEGUARD 30® / LIFEGUARD 40

TUTA PROTETTIVA *PROTECTIVE COVERALL*

CARATTERISTICHE TECNICHE

- + Cappuccio con elastico
- + Traspirante
- + Bordo elastico alle caviglie e ai polsi
- + Elastico posteriore in vita per un'aderenza superiore al corpo
- + Taglio confortevole
- + DPI I categoria

TECHNICAL FEATURES

- + Hood with elastic border
- + Breathability
- + Elastic band at ankles and wrists
- + Back elastic band at waist, for an extra body adherence
- + Comfortable style
- + PPE I category

Codice <i>Product code</i>	Descrizione <i>Description</i>	Composizione <i>Composition</i>	Colore <i>Colour</i>	Taglie <i>Size</i>	Cartone <i>Carton</i>
101401	Tuta protettiva 30 g/m ² <i>Protective coverall 30 gr/m²</i>	PP	○	M/L/XL/XXL	50 pz/pcs
101401-40	Tuta protettiva 40 g/m ² <i>Protective coverall 40 gr/m²</i>	PP	○	M/L/XL/XXL	50 pz/pcs



101401 - Verificare sempre la disponibilità.
101401 - Always check availability.

IGIENE DELLA PERSONA
PERSONAL HYGIENE



Scansiona il QR Code
Scan the QR Code

www.sanita.dermarays.it

DERMARAYS⁺

LINEA DI PRODOTTI PER L'IGIENE DELLA PERSONA
DEDICATA AI SOGGETTI FRAGILI NON AUTOSUFFICIENTI
E CON PELLI SENSIBILI

I prodotti **DERMARAYS[®]** sono specifici per i trattamenti quotidiani di igiene, prevenzione e protezione della cute delicata dei soggetti fragili con pelle sensibile. La gamma **DERMARAYS[®]** è ideale per la gestione dell'igiene del paziente incontinente e non autosufficiente poiché formulata con attivi come **Lattoferrina, Complesso Idratante Reticolato, Aloe Vera e Zinc Coceth Sulfate** efficaci per riequilibrare e rispettare il pH cutaneo, garantire un' idratazione prolungata, lenire gli arrossamenti ed eliminare i cattivi odori.

Prive di coloranti, parabeni, siliconi, petrolati, alcol, OGM, PEG, SLES, SLS, le formulazioni **DERMARAYS[®]** sono dermatologicamente testate su pelli sensibili.

*DERMARAYS[®] products are specific for daily hygiene, prevention and protection treatments for the delicate skin of fragile subjects with sensitive skin. The **DERMARAYS[®]** range is ideal for managing the hygiene of incontinent and non-self-sufficient patients as it is formulated with active ingredients such as **Lactoferrin, Cross-Linked Moisturizing Complex, Aloe Vera and Zinc Coceth Sulfate** which are effective in rebalancing and respecting the skin's pH, ensuring prolonged hydration, soothe redness and eliminate bad odors.*

*Free of dyes, parabens, silicones, petrolatum, alcohol, GMO, PEG, SLES, SLS, **DERMARAYS[®]** formulations are dermatologically tested on sensitive skin.*





Detergere / Cleanse

Detergere correttamente la pelle è un processo delicato ed importante ad ogni età, ma lo diventa ancora di più nel caso di pelli ipersensibili a causa di condizioni individuali o esogene: le formulazioni Dermarays® sono studiate proprio per rispondere a tali esigenze. Tra i numerosi prodotti della linea detergenza sono presenti, inoltre, trattamenti senza risciacquo, per rispondere alle necessità di operatori o familiari che si prendono cura dell'igiene di soggetti non autosufficienti ai quali è temporaneamente sconsigliato il risciacquo con acqua.

Properly cleansing the skin is a delicate and important process at any age, but it becomes even more so in the case of hypersensitive skin due to individual or exogenous conditions: Dermarays® formulations are specifically designed to meet these needs. Among the many products in the cleansing line, there are also no-rinse treatments, to meet the needs of operators or family members who take care of the hygiene of non-self-sufficient individuals for whom rinsing with water is temporarily not recommended.



Igienizzare / Sanitize

Pur compiendo una intensa azione igienizzante e purificante, i prodotti Dermarays® rispettano il film idrolipidico della pelle, grazie alla presenza di principi attivi che proteggono e stimolano le difese immunitarie, presenti naturalmente sulla cute.

While performing an intense sanitizing and purifying action, Dermarays® products respect the hydrolipidic film of the skin, thanks to the presence of active ingredients that protect and stimulate the immune defences, naturally present on the skin.



Idratare / Moisturize

I trattamenti idratanti Dermarays® sono studiati per ripristinare il naturale film idrolipidico della pelle che ha il compito di proteggerla dagli agenti esterni, contribuendo a prevenire problematiche di secchezza cutanea (xerosi) o patologie più serie come dermatiti o cheratosi. Il blend di principi attivi extra idratanti, come Acido ialuronico, Serina, Trealosio ed Urea, presenti nei trattamenti della linea, sono resi ancora più efficaci dalla forma "reticolata", in grado di rilasciare gli attivi in maniera graduale e prolungata.

Dermarays® moisturizing treatments are designed to restore the skin's natural hydrolipidic film which has the task of protecting it from external agents, helping to prevent problems of skin dryness (xerosis) or more serious pathologies such as dermatitis or keratosis. The blend of extra moisturizing active ingredients, such as Hyaluronic Acid, Serine, Trehalose and Urea, present in the treatments of the line, are made even more effective by the "reticulated" form, capable of releasing the active ingredients gradually and prolonged.



Proteggere / Protection

Le zone umide e calde del corpo (come le ascelle, gli spazi interdigitali o il perineo) ospitano una flora diversificata ed abbondante che può portare a severe irritazioni e patologie. I bambini o le persone incontinenti subiscono inoltre l'aggravante del contatto con le fuoriuscite pertanto il trattamento delle aree delicate è di primaria importanza per la salute della pelle e dell'organismo.

The humid and warm areas of the body (such as the armpits, the interdigital spaces or the perineum) are home to a diverse and abundant flora that can lead to severe irritation and pathologies. Children or incontinent people also suffer the aggravation of contact with spills, therefore the treatment of delicate areas is of primary importance for the health of the skin and the body.



Igiene Orale / Oral hygiene

La mucosa della cavità orale è caratterizzata da uno strato superficiale di cellule che si rigenerano ogni 7-14 giorni. Sotto la mucosa, le ghiandole salivari e sebacee hanno importanti funzioni per la lubrificazione, pulizia della mucosa, pulizia della lingua, controllo sullo sviluppo batterico. Se non viene eseguita una corretta igiene orale, si possono presentare serie patologie come parodontiti, gengiviti, formazione di ulcere o ascessi.

The mucous membrane of the oral cavity is characterized by a superficial layer of cells which regenerate every 7-14 days. Under the mucosa, the salivary and sebaceous glands have important functions for lubrication, mucosal cleaning, tongue cleaning, control over bacterial growth. If proper oral hygiene is not performed, serious pathologies such as periodontitis, gingivitis, ulcer formation or abscesses may occur.

Le immagini hanno il solo scopo di raffigurare i prodotti.
I prodotti possono subire modifiche.

La Rays spa si riserva di modificare i dati tecnici,
le caratteristiche dei prodotti ed eventualmente le
referenze, senza che tali azioni possano comportare
conseguenze e/o obblighi nei confronti di terzi.

The images have the sole purpose of depicting the
products.
The products may undergo changes.

Rays spa has the right to modify without notice
any technical data, products characteristics and
references, without any consequences or obligations
towards third parties.

Medicazione tradizionale
Traditional dressing products

Guanti chirurgici
Surgical gloves

Guanti esame
Examination gloves

Aghi e siringhe
Needles and syringes

Dispositivi per il diabete
Devices for diabetic therapy

Dispositivi per terapie infusionali
Infusion therapy devices

Terapia e Diagnostica
Therapy and Diagnostics

Tessuto non tessuto, prodotti per operatori sanitari
Non-woven fabric, products for healthcare workers

Igiene della persona - Dermarays
Personal hygiene - Dermarays



RAY S.p.A.
Via Francesco Crispi, 26 - 60027 Osimo (AN) - Italy
T +39 071 2868935 / 2868468 - F +39 071 2868911 / 2910403
www.rays.it - info@rays.it